

THE LINE MODEL OF FORM AND EMOTION: PERSPECTIVES ON WESTERN DESIGN

Lewis Urquhart

*Department of Design, Manufacture and
Engineering Management
University of Strathclyde, Glasgow
Scotland*

Andrew Wodehouse

*Department of Design, Manufacture and
Engineering Management
University of Strathclyde, Glasgow
Scotland*

Abstract: *This paper introduces a new model of form, emotion, and semantics through a process of form abstraction utilizing lines. Understanding the emotional and semantic value of form is a complex task, and many theories have been developed. Analyzing the visual arts through line relationships and interactions is a conceptually novel approach and offers new avenues for advancing studies in form theory, theories of emotion and perception, and design generally. By examining literature in visual perception, form theory, and emotion, and by historically analyzing changes in form through the aesthetic arts and then reducing these aesthetic elements into basic linear foundations, we developed the line model of form and emotion. This preliminary model presents form at its structurally most abstract, simplifying three dimensionally defined shapes into line relationships, and portrays their emotive and semantic associations for human observers. The model also visualizes the historical changes in form and emotional and semantic meaning across time, from the 18th century to the present day.*

Keywords: *form theory, design emotion, aesthetics, semantics.*



INTRODUCTION

Understanding the emotive and semantic relationships of form¹—the boundaries and structural composition of shape (Arnheim, 1954)—and the perception of form have been research focuses in science and philosophy for generations and is now an expanding area of design research (Desmet & Hekkert, 2014). Industrial design and architecture are perhaps the disciplines where understanding emotional experience of form properties is most pertinent and where the expressions of societal values through objects possibly become the most tangible and the most emotionally relevant. Having the knowledge to conclude that one form is objectively more desirable from an emotional point of view, at least within a specific societal context, can help designers create more desirable or more beautiful objects. Indeed, such an analysis can even help designers to understand themselves and their place within an ever-evolving culture of aesthetic arts and technological change.

This recent interest regarding the emotional content of form, objects, or products in the Western world² opposes the brand of rationalism implicit within the modernist design philosophies that so dominated the early 20th century. The modernists of the mid-20th century, such as Alvar Aalto or Greta Grossmann, slowly rebranded traditional modernist design into a kind of rational-beauty: Design could reach a certain degree of elegance and perfection where the idea of a brute functionalism was less dominant, and the designs were more emotionally attuned. The user of a product could engage both with its function and its elegant beauty. Over the final decades of the century, design became much more intertwined with what became known as user experience largely due to the emergence of the digital interface and the personal computer (Hassenzahl & Tractinsky, 2006). Part of the success of Apple Macintosh's product line of personal computers was due to the meticulously designed interface combined with tangible experiential qualities encompassing properties of form, sound, and tactility: Product construction was fused with a more abstract emotional experience (Norman, 2004). Work such as Alan Cooper's *The Inmates are Running the Asylum* (1999) presented an early analysis of what is now referred to as experience design by decisively arguing that poorly designed technological interfaces frustrated users. Since then, some of the important studies on design, emotion, and experience, such as British industrial designer Patrick Jordan's *Designing Pleasurable Products* (2000) or cognitive scientist and designer Don Norman's *Emotional Design: Why We Love (or Hate) Everyday Things* (2004), have paved the way for many more detailed studies of these phenomena. Norman's influential work introduced several concepts into a model for understanding emotional design that fused affordance theory developed by Gibson (1979) and modern design interaction psychology (see Norman 1988, 1999, for more detail). His three levels of emotional engagement—visceral, behavioral, and reflective design—express the differing qualities that design can exhibit, properties that depend on an artifact's form and interaction characteristics.

Recent work by design theorists Hekkert and Berghman (2016) in experimental aesthetics has introduced a unified model of aesthetics that describes the aesthetic experience in product design and the built environment. This model postulates that aesthetic appreciation is constructed from three main principles of conflicting aesthetic qualities: unity-in-variety; most-advanced-yet-acceptable (MAYA), or an artifact displaying typicality, and novelty simultaneously; and symbolized connectedness and autonomy. A comprehensive analysis found that these conflicting qualities—unity-in-variety, in particular—do influence aesthetic

appreciation overall (Hekkert & Berghman, 2016). Other recent work has extended the MAYA concept to explicitly develop a process of form-driven meaning innovation using radical curvilinear and rectangular forms to innovate away from a design archetype and to imbue designed objects with meaning (Lee, Self, & Andrietc, 2016).

The emotional desirability of a product is now a central concern for much contemporary design, as illustrated by these studies. A new belief has arisen where (according to Hekkert, 2006, among others) elegance, beauty, and novelty in form can translate into a meaningful product experience. Indeed, the emergence of techniques such as Kansei engineering, which explicitly orientates design around the subjective emotional experiences of users through cognitive and physiological testing, is emblematic of this philosophical and cultural shift (Lévy, 2013). This research is an examination of the fundamental aesthetic principles that underlie this supposed experience of form: geometry and its emotional and semantic connotations.

In this paper, we firstly analyze four strands of literature: form theory and perception, psychology of emotional experience, semantic theory of form, and recent historical changes in aesthetics. Secondly, we propose a novel method for distilling form into its critical abstract components by making use of Rowena Reed Kostellow's (cited in Hannah, 2002) design and composition theory and Panofsky's (1939) iconographic approach to compositional analytics. Our method considers a range of examples from industrial design and architecture. All of these are expressions of complex creative, philosophical, social, and technological developments across time. The aim of the analysis is to present some understanding of how the form and structure of designed objects, architecture, and the built environment can influence human emotion, which is a highly relevant concern for contemporary design practice (Desmet & Hekkert, 2014). Ultimately, we present an initial draft of the line model of form and emotion, where form is presented as a theoretical abstraction—as two-dimensional line relationships that can be related to specific emotive states and semantic values. Line is the starting element in design work, whether it is digital or utilizing drawing tools, and concepts are formed from sets of line arrangements in two-dimensions that create a representation of structure (Hann, 2012). By analyzing objects through line abstraction, we lay bare the underlying structure of the designs and are afforded the possibility of unpacking their emotional content.

Our paper takes a discursive and philosophical approach, combining many forms of literature with the central aims: (a) to develop a deeper understanding of changing aesthetic form motifs across the recent history of Western design and architectural output, and (b) to link emotional experience to these form developments and changing semantic values. Using an iconographic method (described in the chapter Form and Line), sets of form and structural qualities can be shown to be archetypal features of designs from certain historical periods. The psychological experience of form and its relation to emotion and other cultural aspects, what has been called the aesthetic encounter, is highly complex and any explanatory model must consider a broad range of societal and physical factors (Csikszentmihalyi & Robinson, 1990). Given this intrinsic complexity, our model is not a complete picture and, although we have set out and followed a procedural distillation and allocation of form elements in relation to emotion and historical contexts, we acknowledge that other interpretations are possible and equally valid. The presented model is an initial draft that attempts to unify historical time, form, and emotion in a way that is meaningful and helpful for designers and researchers wishing to understand, discuss, or apply contextually and experientially attuned form elements. The model

should be advanced and adapted with insights from future research. The overall limitations of the work are discussed at length in the Discussion chapter.

FORM AND EMOTION

Form has many different meanings, from something entirely homogeneous and definable (e.g., a table or chair) to something with high levels of abstraction (e.g., a point or a line). The arguments concerning the nature of form have been debated for millennia. Plato's extremely influential work from the 3rd–4th centuries BC defined form as an answer to questions such as what is a cube or what is a horse? Plato theorized a state of form that is both aspatial and atemporal, transcendent to both space and time, existing in a kind of perfect metaphysical position (Cornford, 1957). Aristotle's later theory of hylomorphism (3rd century BC) changed elements of Plato's theory by stating that human perception of objects is built of two elements: the matter and the form of that matter (Ainsworth, 2016). Matter in this respect is changeable and malleable, like a sculptor creating a statue. At the start of the work, marble exists in the form of a crude cube; over time, its form is transformed to that of a Roman emperor, for instance. This theory of form, where form (*morphē*) is independently conceived by a human actor and imposed upon matter (*hyle*), has become, as argued by anthropologist Tim Ingold (2009), a pervasive feature of Western thought, form theories, and modern conceptions of design.

Design theorist Michael Hann extensively detailed elements of form and human perception of it, and has proposed that form consists of sets of structural elements. Geometry flows from points and lines and is organized by principles such as balance, contrast, and rhythm that influence human perception of it (Hann, 2012). Indeed, Hann argued that a line can be considered either a moving point or the path between two points. He simultaneously argued, following Ingold (2009), that lines can be conceptualized as a leap from one state to another, a flow of continuous energy that forms the basis of structure.

Both Hann's (2012) and Ingold's (2009) concepts present form as a more fluid phenomenon, perceptually in flux and changeable. Plato and Aristotle's traditional ideas have had a profound influence on much of the subsequent European artistic practice (Rockmore, 2013). Modern conceptions of relating specific forms to certain semantic ideas and specific emotive values still relate to these classical conceptions very strongly—where people see human intentions manifest through the very structures humans create. Delving more deeply, it is possible to examine what the character of form is and the associations that human observers draw from visual interaction with it. What, for instance, does a curved form, as opposed to a rigid and angular one, mean to human observers emotively or semantically? Or what does it mean to experience a form? A body of scholarship and empirical work has attempted to deal with these questions.

The Character of Form

The form of objects and the built environment acquire meaning through emotional engagement with them (Desmet, 2003). In the 18th century, artist and critic William Hogarth (1753/1997) argued in his aesthetics treatise, *The Analysis of Beauty*, that a representation of beauty can be

found in a simple wavy line. From his diagram (Figure 1), Hogarth indicated that line number four has the true essence of a beautiful form, with the others being described as bulging, clumsy, mean, and poor (Hogarth, 1753/1997, Chapter 10). Hogarth's thesis presented protomodern empirical ideas relating abstract shapes and lines to specific emotive and semantic properties. Modern work in cognitive psychology analyzing visual perception has presented evidence that suggests human beings have a natural inclination to prefer curved forms to angular ones, partially validating Hogarth's initially subjective insights (Bertamini, Palumbo, Gheorghes, & Galatsidas, 2016). Curves, it seems, have long been a prominent feature of artistic or creative expression; examples of curving imagery, such as waves and abstract impressions of animal movement, are present even in the cave painting of Paleolithic humans dating back some 20,000 years (Clottes, 2016).

Questions concerning the experience of form—shape, curves, angularity, and form's overall structural foundation—often have been approached using categorizations of form qualities. Research within perception and emotion has tended to focus on form as an abstract entity: a nondescript, isolated shape or simply a line, usually characterized by implicit angularity or curvature. Research in the psychological sciences has shown consistently that humans are inclined toward curved forms (Bertamini et al., 2016). This experimental work typically utilized isolated form abstractions in a variety of contexts to demonstrate this inclination. Early work by psychologists Poffenberger and Barrows (1924) showed that angular stimuli were associated semantically with words such as powerful, serious, or hard. Their experimental work used 18 variations of simple line drawings, all with a wave-like sinusoidal structure and varying in frequency, and participants were asked to assign sets of adjectives to each. The curved forms were associated with words such as gentle, quiet, and playful, meaning people identified important experiential distinctions among the different lines. Notably, small changes in the axis angle of the lines altered their semantic value. For example, a wavy line initially associated with the word *gentle* became associated with the word *lazy* when rotated clockwise slightly. Similar results have been recorded more recently by Collier (1996) and by Bar and Neta (2006), who utilized common objects and what they termed meaningless patterns, that is, sets of arranged

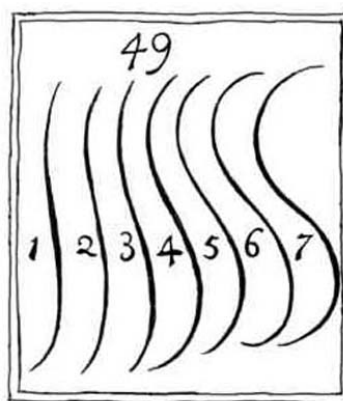

Figure 1. Hogarth (1753/1997), in his aesthetic treatise, *The Analysis of Beauty*, related line styles to emotional and semantic categories. Hogarth considered a selection of different line stylings and argued that line number 4 represented the ideal form of beauty.

Note. William Hogarth [Public domain], via Wikimedia Commons, https://commons.wikimedia.org/wiki/File:Serpentine_lines_from_William_Hogarth%27s_The_Analysis_of_Beauty.jpg

abstract shapes. Both studies showed participants had a higher preference for curved objects and patterns as opposed to the angular variations. Additional work relating expressly to industrial design has noted a trend in recent automotive interior design toward curved structures and away from the angularity so extensively seen in the 1980s and '90s (Leder & Carbon, 2005).

Research by psychologist Marco Bertamini and others (2016) has sought to understand the curvature response more comprehensively by evaluating how perception of form and lines of abstract shapes is influenced by other factors, such as perceived complexity, visual information, and color. In a set of experiments, the researchers found that curved forms were preferred in a wide variety of contexts. In one experiment, abstract curved forms were preferred over angular ones, and angularity was notably associated with complexity. Critically, the context of the lines did not seem to affect the propensity for curvature preference.

Many studies suggest that some visual preferences are innate or possibly are instilled at a very early age (Lewalski, 1988). At the biological and cognitive levels, however, explanations vary. Some researchers have concluded that the human propensity to dislike angular structures is some form of primitive threat response, reminding humans of teeth or treacherous environments (Bar & Neta, 2006). Related work by design theorist Del Coates (2003) attempted to integrate form perception with cognition and information theory using a concept named concinnity, broadly defined as a sense of harmony. Coates considered two types of concinnity: (a) objective, which speeds the process of pattern finding or the intelligibility of interacting with an object, for example, and (b) subjective, defined as emotional cues that speed up the mental processing of an object's meaning (Coates, 2014). Thus, a sphere can be said to have the maximum amount of objective concinnity in a three-dimensional environment, given its bilateral symmetry across any central axis (Coates, 2003). The concept of concinnity relates directly to mathematical theories of smoothness. In this context, the rate of curvature is known as curvature continuity. Figure 2 illustrates through line relationships the differences between the geometric categories with the definable tangent points marked. What is called G-0 continuity is positional, where two surfaces share a single and definable edge. G-1 continuity is tangent where the surfaces share an edge but there is no discernible break in the transition from one surface to the next. G-2 continuity, or curvature continuity, is defined by surface planes having equivalent rates of curvature before joining; in this way, the points of surface transition become theoretically undefinable as one curved surface moves into another (Foster & Halbstein, 2014). Thus, any object capable of being visually perceived by humans can be abstracted into one of these simple line relationships. Indeed, work by the computational design theorists Mothersill and Bove (2015) has directly applied this psychological work to develop a form and emotion typology.

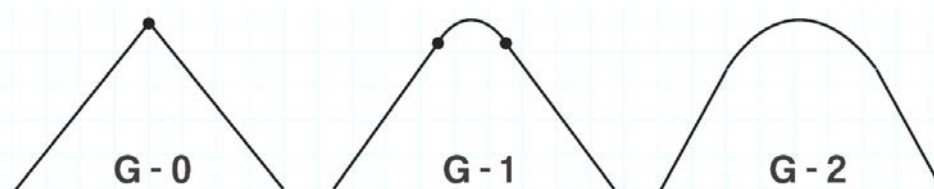

Figure 2. Three levels of curvature continuity that form is geometrically abstracted into for use in mathematical analysis and computer aided drawing software. G-0 represents positional continuity, G-1 represents tangent continuity, and G-2 represents curvature continuity.

The Experience of Emotion

Although we have considered literature that demonstrates how humans relate form to emotional experiences, we further examined what we mean by *emotion* and *experience* and how emotions can be categorized. American philosopher John Dewey wrote extensively on aesthetics and described the term experience as an event that is demarcated by a clear beginning and end, ultimately creating a whole. Discrete activities shape the experience, what Dewey referred to as the relationship between “doings and undergoings” (Dewey, 1934, p. 44). This definition is useful when examining human interactions with form. The experience of having an emotional response to an aesthetic object can be viewed, in Dewey’s terms, as a discrete activity that shapes the overall experience cognitively.

Work on emotional experiences is extensive and many theories have been proposed (see Izard, 2009, for a detailed summary). Some of the earliest theories were purely physiological: It was understood that emotions could relate to differing facial expressions. Delving back even further, the ancient concept of the four humors (blood, black bile, yellow bile, and phlegm) considered emotion as a constituent part in producing disease by causing imbalance in the secretion of one of the four fluids. Notably, historic conceptions of emotion were physiological: An emotion could affect the body in a tangible way. In the 17th century, following the influential work of Descartes (1641/1911), the mind and, by extension the experiences of the mind, were demarcated from the physical object of the brain. This idea, known today as mind–brain duality, led to the view that emotions were beyond the realms of empirical understanding. Because the mind was considered separate from the brain, a nonphysical and nonspatial substance, it could not, by definition, be empirically examined. The reality of how physical body parts create huge varieties of subjective experiences is still a major challenge in philosophy and science, conceptualized by Chalmers (1995) as the hard problem of consciousness. Regardless, this dualistic view began to break down toward the end of the 19th century, when the emerging psychological sciences started to examine discrete experiences such as perception and emotion. Some of the earliest research into what constitutes a human emotional experience that is meaningfully scientific begins with William James, the American psychologist and philosopher of the pragmatist school. James’ (1884) theory proposed that emotion was a function of an antecedent arousal state. The body’s experience of physiological change as the result of an incident or event and the emotional sensations that follow constitute much of the physiological alterations through a system of feedback (e.g., a quickening heart beat when one is frightened). This inversion of the more linear approaches to emotion understanding was radical and has proved challenging to disprove with elements of it being integrated into modern neuroscientific theories (Dalgiesh, 2004). Aspects of the theory have however been criticized since its development and, more recently, theories have considered other factors as the central mode by which emotions operate. The Cannon-Bard theory, for instance, presented evidence that directly opposed James’ theories by proposing that stimulation of the hypothalamus led to emotional experiences rather than a process of feedback (Cannon, 1927). Work by Barbalet (1999), however, suggested that James’ views on emotion have been consistently misunderstood and that the apparent Cannon-Bard disproving of his theory amounts more to a misinterpretation of James’ thought.

Because it became abundantly clear through competing theories that emotions as discrete experiences were difficult to analyze, researchers began to question what role emotions play

and why they are present at all in human experience. Research from the mid-20th century considered the functional role that emotion plays both in terms of human development across time and the social functions of emotion. One prominent theory posited that an emotional experience is built from physiological stimuli and contextual cues of a process of cognitive labeling that allow the experience to be understood (Schachter & Singer, 1962). This two-factor theory demonstrated how emotion cannot necessarily be understood in simple terms of physiological change; it requires an intelligible contextual foundation without which an emotional state can be misattributed (Dutton & Aron, 1974). Other theories, such as those from the behaviorist school of thought, proposed that human emotion is a learned behavior that is determined by environmental changes or by systems of reinforcement or punishment, that is, a kind of conditioning (Staats & Eifert, 1990).

Some of the most influential theories of emotion have drawn on the perspective of cognition, meaning the mental processing of stimuli. Lazarus (1991), for instance, considered emotions of high importance in general human reasoning, in what has come to be called appraisal theory. This model developed the earlier two-factor theories by incorporating a factor of cognitive intentionality. As Lazarus argued, the fact that an event can be interpreted and understood in a particular way will lead to an emotional response followed by an action of some description—a cognitive appraisal—followed by a physiological change characteristic of an emotion, followed by an action response. This model has proved influential in situations where emotion serves as a functional tool that can guide the body in some manner. A theory from Frijda (1986) explored the possibility that emotions elicit action tendencies that, in turn, advance certain behavior. Thus, the cognitive appraisal is more closely associated with an end action. This multifaceted behaviorist view proposed that emotions serve certain fundamental human needs, a view also held by Solomon (1977), who argued that emotions are types of judgments that can be adapted and revised ways similar to beliefs. In opposition to James' (1884) view, Solomon (1977) argued that one could experience anger without displaying any physiological characteristics of anger (Glazer, 2017). The cognitive theories are generally utilitarian in approach; the abstract sensation or a feeling of emotion has a tangible function that assists in the understanding of an event, ultimately aiding survival in an evolutionary framework.

More modern work on emotional experience has posited a wide range of theories and concepts. These can be considered broadly in two categories: physical theories and phenomenological theories. For the purposes of this work, we will be considering the phenomenological approaches whereby the characteristics of emotional experiences are examined. Physical theories are extensive (see Dalgiesh, 2004, for a summary) and fundamental in an overall understanding of how brain functioning might cause emotion. However, these theories do less to advance the understanding of the experience itself. Indeed, Lisa Feldman Barrett's (2006) theory of constructed emotions took a psychosocial approach and indicated the experience of emotion as a function of interoception, or the feeling of an internal bodily state, a person's understanding or interpretation of discrete concepts, and the social context from which the individual comes. From this point of view, each discrete experience of an emotion has been constructed by a range of factors, including sets of powerful cultural influences. Other work (e.g., Butler, 2017) has suggested that emotions extend beyond individuals and operate as a kind of social system, a temporal structure that exists between and among people as they communicate. Another prominent contemporary theory explores the possibility that human understanding of emotions is driven only by a so-called direct perception;

for example, when someone is smiling, this is the only way that the emotional experience of that person (happiness) can be epistemically known (Gallagher & Zahavi, 2012). This conclusion can, however, be challenged by pointing out that expressions may mean different things in different cultures.

Categorizing Emotions

While the various theories explore the process and origin of emotional experience, work also has been undertaken to describe and categorize the varieties of emotional experiences. The idea of classifying emotions dates to ancient times. Gradually, factors of discrete human experience and facial expressions became related to particular feelings or sensations, such as pain or nausea, and specific emotions. In a process that Dixon (2003, p.180) referred to as the “creation of the emotion,” the experience of emotion was recast as a physical mechanism during the late 18th century.

This consideration of emotions as distinct categories of experience has been followed until the present day and is a useful tool when examining human emotional responses to stimuli (visual form, for example). One of the most influential modern theorists, American psychologist Paul Ekman, proposed a model of basic emotions, where emotions are discrete and measurable states. In a seminal set of studies, he put forward that emotion can be split into six broad categories: anger, disgust, fear, happiness, sadness, and surprise (Ekman, 1980). The categories were produced from facial expression studies across various national cultures. Later, this list was expanded to include amusement, contempt, contentment, embarrassment, excitement, guilt, pride in achievement, relief, satisfaction, sensory pleasure, and shame (Ekman, 1992).

Similar to the work of Ekman is the prominent model of emotion categories developed by American psychologist Robert Plutchik (1980). Known as the wheel of emotions, it attempts to show the relationships between distinct classes of emotions and how emotive categorizations are not necessarily discretely definable and emotional states themselves are highly transient, a point also intimated by the more recent models of Russell (2003). For example, the intensity and character of feeling in the emotion known as joy is similar (according to Plutchik, 1980) to that of anger. What makes the experiences of these two emotions distinct is the context: What has been experienced and to whom it has occurred are points considered paramount in many of the theories described earlier. Other useful models include the work of Shaver, Schwartz, Kirson, & O’Connor (1987) and Cowen and Keltner, (2017), who defined 27 distinct categories of emotion. This discussion of categories of emotional experience brings up a question: If there are categories of emotional experience, can there be categories of form experience that relate in some way to emotive states?

Relating this back to the discussion regarding form experience, the context of form is important. Much research has shown that isolated geometry can relate to distinct emotive classes. The task of understanding emotional responses to aesthetics has been challenging for researchers due to an aesthetic sense in the human animal not having an immediately obvious evolutionary advantage. Clearly, emotion serves a range of very complex functions and it must be considered how emotive responses to form serve both fundamental human needs, such as cognitive processing, and understanding of the environment and socially constructed

needs and values, such as taste or fashion. Categorization is critical to consider and will help to provide foundation to the form and emotion model presented later.

Emotion may be the principal factor for an experience of form. Recent architectural theory has associated aesthetic ideals with human needs and values. Gaston Bachelard's (1958/1994) work, *The Poetics of Space*, explicitly considered the emotive experience of architectural form from a phenomenological perspective. Similarly, Pallasmaa (2012), in his *The Eyes of the Skin*, argued that modern architecture should be multisensorial and posited that there is a current bias toward the visual experience of form, rather than an experience that values other senses, such as touch and hearing. Modern research in aesthetics, drawing on Dewey's (1934) initial foundation, has considered the process of aesthetic appreciation as an experience. The model proposed by Leder, Belke, Oeberst, & Augustin (2004) considered the experience of art or form to be constructed by a complex system of feedback, where an analysis of the form, emotional affective state, memory, prior knowledge, and social setting all play a role in a resultant aesthetic judgment and emotion. In an updated version, more prominence was given to the emotional affective state of the observer as the driver of the overall experience (Leder & Nadal, 2014).

Semantic Properties of Form

Certain forms acquire meaning, either spontaneously or with repeated exposure to them, in what can be considered a semiotic process. In the context of design, particular forms have become iconic design archetypes. One of the best examples is the push button, which is now a near ubiquitous feature in consumer electronics interfaces (both physical and digital). In a broad sense, the meaning being conveyed by this type of design component is change. When a button is pushed, when force is applied, one expects something to happen. Norman (1988, p. 9) described this expectation as an "affordance," expanding the original affordance concept developed by vision psychologist J. J. Gibson (1979). This also relates to what Gaver (1991) described as hidden and perceptible affordances. The form of an object conveys a meaning—a button suggests "pressability" and the handle of a mug suggests "holdability" (You & Chen, 2007). The form possesses certain characteristics suggesting manipulation, and from these its meaning is derived. Indeed, it has been shown that these form–affordance relationships are present in a wide variety of products where form manipulation, interaction, and function are critical (Urquhart & Wodehouse, 2016).

The seminal work on semantics was undertaken principally by Krippendorff and Butter (1984), and in a later text by Krippendorff (2005), as part of a major paradigm shift in design thinking. Krippendorff and Butter (1984, p. 4) described product semantics as the study of the "symbolic qualities of man-made forms in the context of their use." This was recognized as an important field of research during the computer revolution in the 1980s, when graphical user interfaces had to be intelligible and convey meaning for users who held little knowledge of computer systems. Design was recast as process of communication with an explicit link between the designer's intention and the user's interpretation (Vardouli, 2015). As Krippendorff (2005, p. 45) stated, meaning matters more than function in the context of design: "The engineers' functions are meaningful to engineers, but these functions are not the only truth and not necessarily shared by nonengineers." Meaning is thus defined as a manifestation of perception, functionally equal to an object's affordances or its imagined uses. Moreover, meaning is always a construction, is not conceptually fixed, and emerges as a result of language use. When

humans interact with form, its meaning to them is a construction and can change gradually over time or abruptly with the input of new information or sensory experience. Other research has accumulated illustrating the importance of form in the context of user experience and how products are commercially successful (see Bloch, 1995, for a detailed study). Additionally, recent work has suggested that the form of an object articulates interaction aesthetics and interaction affordances (Xenakis & Arnellos, 2013). The interaction aesthetic influences the selection of best action options with respect to an object's characteristics through a process of dynamic presupposition of interaction.

In the wider world of the visual arts, semantics and semiotics are of considerable importance and interest. Objects that appeared in paintings from the European-Christian medieval period, for example, were widely known symbols or metaphors and many of these are still present: The apple represents the fall of man into sin and the white lily suggests godly purity, to name but two examples. The main difference to address here between these semantic properties and the emotive ones is that the former are social constructions that develop semiotically over periods of time, whereas emotive reactions are more innate. As Hekkert (2006) described, many factors can influence the attribution of meaning, such as interpretation, memory, and natural associations. Over time, meaning experienced through form at the individual level can become more stable, becoming archetypal and symbolic and representing specific cultural concepts (Sudjic, 2008).

Forty (1986) studied the development of designed artifacts from the perspective of societal use and value and noted a large array of form variations across many different products. The notable examples are the differences in design and form features for products aimed respectively at men or women or the upper versus lower classes of society. (A similar effect, but much more explicit, is seen in products designed for children as opposed to adults.) Forty (1986) noted that products such as watches designed for women, historically, would have a higher frequency of ornamentation; designs for males were less ornate. McCracken (1986) noted that preferences for product form are shaped by powerful social and cultural forces. The implication of this is that products have different meanings to different users. Similar examples are seen in the different strata of society: There is a complex relationship between form, gender, class, society, and meaning (Forty, 1986). Indeed, postmodern philosophers Deleuze and Guittari (cited in Porter, 2009) saw the expression of form, in designed objects or buildings, as indelibly connected to the political and where initial form abstractions are actualized and become tangible symbols of change across time. Form, even abstractly conceived, is replete with emotive and semantic value in which many things are designed with the expressed intention of conveying a meaning. As design critic Deyan Sudjic (2008, 2011) observed, the popular typeface Helvetica (Figure 3) was designed as a symbol of Swiss precision and discipline, and similarly, the architecture of fascist-controlled Europe was deliberately symbolic of an imposing power and control.

Deriving Meaningful Forms

The Gestalt theorists of the early 20th century were some of the first to analyze perception in detail. The central concern of the Gestalt theorists lay in how objects, forms, and structures are cognitively grouped and/or abstracted as they are viewed. Their central mantra maintains that the whole is other than the sum of its parts (Ellis, 1938). They proposed several principles that

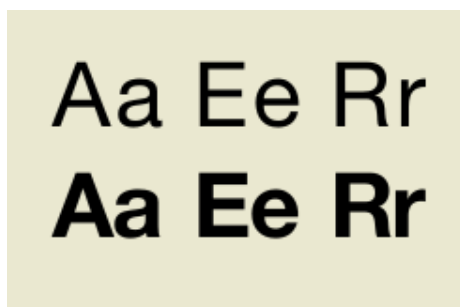

Figure 3. The Helvetica typeface was created to be symbolic of Swiss discipline. Standard and bold variations are shown.

Note. By GearedBull Jim Hood (Own work) [GFDL (<http://www.gnu.org/copyleft/fdl.html>)] via Wikimedia Commons <https://commons.wikimedia.org/wiki/File:HelveticaSpecimenCH.svg>

influence visual perception, the so-called principles of grouping that include proximity and symmetry, among others (Wertheimer, 1923). These principles are part of a wider theory of how humans cognitively process visual elements and how (to include Gestalt’s recent research trends) shapes can lead to meaning creation (Pinna, 2010).

The famous optical illusions produced by the Gestalt school (see Figure 4) illustrate their theories of the holistic perception and processing of forms. Review work by Pinna (2010) explored a wide variety of optical illusions constructed and explained by the principles of Gestalt. Pinna extended the Gestalt principles to incorporate a meaning-making process. As Pinna argued, the Gestalt principles of grouping forms cannot fully explain the nature of these meanings, but there appears to the observer a sense of “happening” within the structure of the observed forms: The meaning spontaneously grows from the context.

Norman’s (2004) model of form experience differs from the Gestalt theories of perception; he argued, for example, that the superficial appearance of a product—that is, the visceral level of engagement—is but one in a trinity of distinct experiences. While Gestalt theorists argue that object perception is cognitively processed as a single whole, Norman suggested that two additional

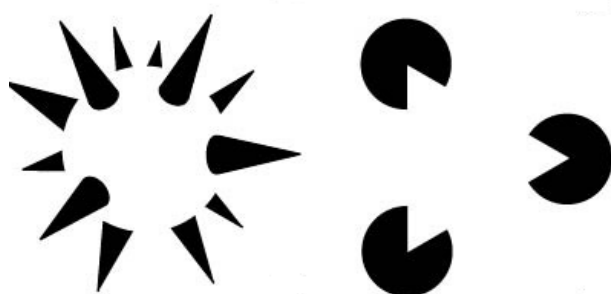

Figure 4. Gestalt optical illusions illustrate how our perception creates a shape that is not in fact there. With the image on the left, a sphere is visualized in the center with conical objects extruding out from it. In reality, there is no sphere and there are no protruding cones; the illusion of three dimensions is a product of how the entire image is cognitively processed. Instead of being understood as a number of discrete elements, it is understood as a whole and acquires meaning. The same effect can be considered for the image to the right.

Note. By Gestalt7.PNG: User: Albert Kok: (Gestalt7.PNG) [Public domain], via Wikimedia Commons <https://commons.wikimedia.org/wiki/File:Gestalt7.svg>

dimensions of behavioral design—namely pleasure during product use and reflective design described as an abstract experience of nostalgia or positive memory recollection—are also at play. In his earlier work, Durgee (1988) agreed with Norman’s (2004) model by suggesting design is experienced atomistically, meaning that product experience is linear, where each design element, the presence of a door or button, for instance, is processed one at a time, contrasting the holism of Gestalt theory. Bloch (1995), however, argued that both interpretations may be true for different contexts.

Seminal work by art theorist and psychologist Rudolf Arnheim (1954) also explored the experience of viewing art, objects, and the built environment. In *Art and Visual Perception* (1954), Arnheim described how the experience of viewing geometry, whether highly structured or more abstract, is fundamentally a process of reasoning or a form of visual judgment, one which is indispensable from the act of seeing itself. Arnheim explored a substantial number of visual perception phenomena that influence how forms are interpreted semantically and emotively. “Perceptual force” (Arnheim, 1954, p. 6) is one of the principle concepts that gives visual perception its dynamic qualities. This force is derived from the visual context of geometry, in logic similar to the Gestalt theorists. For instance, a set of shapes may appear to have a sense of direction and movement as if being acted upon by forces (echoing the later work of Ingold, 2009). Regarding the nature of shape and form directly, Arnheim (1954) noted that form is interpreted holistically: A person will identify the doggishness of a shape before he/she is able to discuss the differences between various dogs (the Platonic ideal where a generic form will supersede specific varieties). This observation distills how meaning is indelibly linked to form perception. Arnheim (1954, p. 37) defined the concept of shape as the “boundaries of masses” and form as a kind of orientation and configuration of shapes whereby certain connotations can emerge from dynamic interactions. This overlapping of visual elements can lead to a sense of unity, for example.

Summary: Key Characteristics of Form

Before introducing the development of our theoretical model, we summarize the critical points of the last sections. We noted that the definitions of form have been debated for millennia. Hann (2012) argued coherently that the main properties of form can be reduced to interactions of points and lines, interactions from which all geometry arises. The line itself and other forms of isolated abstract geometry have been studied extensively, with new movements of perception research generally concluding that humans associate geometric elements with emotive categories or categories of experience. Broadly speaking, humans seem to hold an emotive preference for curvature. This preference, some have also argued, is the result of cognitive processing: It is simply easier to understand curved forms that have less perceptible visual information to process (Coates, 2014). The experience of emotion was also considered closely. Many theories considering the roots of emotion were examined, recognizing the complexities of human emotional experience that is driven by fundamental needs and hugely varied social interactions. Theorists of perception such as Arnheim, the Gestalt psychologists, and the semantics theorists were also considered. They argue that the context of geometry, either isolated and abstract or within the built environment, can radically alter understanding and perception of shapes, allowing them to take on semantic meaning. Arnheim (1954) argued that this process of visual interaction

with form is a process of reasoning, and artistic, design, and architectural developments over the centuries relate to essential aspects of human nature.

In the next chapter, we describe working definitions of form and structure more closely that allowed us to build the model. We understood that our reflections on form and emotion must echo the diversity of theoretical perspectives formed over the centuries regarding emotion, meaning making, perception, and form—as well as the cultural and other influences of all of the above.

FORM AND LINE

The following sections describe the development of our line model of form and emotion as a means of analyzing the emotive and semantic experience of form. The model also shows how the various manifestations of form across time can be interpreted and understood from the perspective of emotional experience, specifically, discrete categories of experience, such as joy or anger. Outlined in this section is our overall method for distilling and analyzing form. We firstly set out the principle of form and structural archetypes to set clear boundaries for our analysis. Secondly, we describe our method for extracting the key two-dimensional line relationships. The method was closely informed by the work of design theorist and educator Rowena Reed Kostellow (cited in Hannah, 2002), specifically how her principles of dominant and subdominant structural elements are applied to refine the understanding of the visual elements. Erwin Panofsky's (1939) iconographic approach to art analysis also informed the method.

Archetypes of Form and Structure

The key challenge we needed to address is how to reasonably find examples from the various epochs in the history of art or design; the nature of this task is intrinsically subjective. Aesthetic development cannot be viewed in a simplistic and reductionist way; it must be approached holistically, with the complex connections, both historical and cultural, laid bare. Thus, in developing our model, we considered the idea of a form archetype. An archetype, in our context, refers to an element of form or structure that is coherent and stable enough to be identified in a multiplicity of places during various historical periods. For example, what we now call neoclassicism has many archetypal features: Doric and Corinthian pillar styles, for instance. While there may be small variations due to factors such as artistic expression, the form can be clearly linked to a certain style prominent during a certain time historically. In this sense, our approach relied upon known and well-developed historiographic narratives. This guided our establishing and analyzing form archetypes.

Similarly, structural archetypes need to be considered. To take neoclassicism again, the overarching structural design is one of order, proportion, and symmetry. The paintings of this period often employed the rules of proportion and perspective conscientiously, following a strict structure (Aristides, 2016). The form around this structure, however, is much more fluid and ornamental, usually consisting of carefully configured curving shapes dominant within the composition. As an example, consider the depictions of the human bodies against the background of a classical city in art of Claude Lorraine (see Figure 5). The organic forms are subordinate to an overall sense of order provided by careful use of perspective and proportion.



Figure 5. Claude Lorraine, Classical cityscape (late 17th century). The prominent art of this period and later sought to represent an idealized version of civilization that was thought to have been lost since ancient Graeco-Roman times.

Note. Claude Lorraine [Public domain], via Wikimedia Commons

[https://commons.wikimedia.org/wiki/File:Paisaje_con_el_embarco_en_Ostia_de_Santa_Paula_Romana_\(Gell%C3%A9\).jpg](https://commons.wikimedia.org/wiki/File:Paisaje_con_el_embarco_en_Ostia_de_Santa_Paula_Romana_(Gell%C3%A9).jpg)

By contrast, the movement now called modernism was, in terms of form, much more abstract, with a dominant use of angularity. However, its structural design, meaning its use of proportion and symmetry, for instance, is strikingly similar to the output of the period 150 years earlier. This relationship will be explored below.

By establishing sets of form and structural archetypes, our analysis could progress. In summary, we established a range of criteria for identifying form and structural archetypes that was useful for developing the line model.

Form Archetypes

We next established how an archetypal form feature could be classified. In our model, we take a historical approach by analyzing changes across time, from the beginning of the neoclassical period (approximately 1750) to the present, so it is essential to clarify how critical changes are measured and categorized. We proposed four critical elements that defined a form archetype, namely (a) a recurrent aesthetic feature, (b) a feature with an identifiable underlying structure, (c) an identifiable character to the form, built from tangent, positional, or curved geometric continuities (see Figure 2), and (d) the possible presence of tangible semantic properties (i.e., the forms conveyed a discrete meaning). These four elements can theoretically be used to broadly categorize dominant features of historical movements in aesthetics. Although these form archetypes represent a more refined form of analysis, we felt the archetypes of structure—or the underlying foundation from which forms are framed and developed—must also be considered.

Structural Archetypes

Structure provides a foundation for form (Hann, 2012), so we considered structural archetypes within this discussion. We proposed three elements to define a structural archetype: (a) an identifiable framework or foundation around which the form is developed, (e.g., a square grid structure from which other, more complex features can be built); (b) conformity (or lack of) to certain rules or formalities, such as proportion, symmetry, and rhythm, or the repetition of elements and motifs, and (c) scalability of the structural design, meaning the design can be identified on the macro scale as well as applied to features of smaller scales, such as ornamentation. Both types of archetypal elements (i.e., form or structural) were crucial to consider in our line analytics. By establishing these key elements, our analytics was more grounded and constrained for developing the model.

Developing the Model

This section will elucidate how the model was developed. As we brought together many elements from a wide range of disciplines, it was important to carefully map our methods that unified several conceptual approaches from art history, design theory, and philosophy.

Theoretical and Philosophical Underpinnings

Our methods relied primarily on theories regarding the interpretation of form from the point of view of emotion and semantics. We considered several notable research methods from the empirical sciences and theoretical and philosophical approaches, such as the Gestalt psychologists. Our base assumption is that form, as it exists to be experienced by humans, has tangible effects on them leading to interpretations of meaning (semantics) and emotional experience. In the previous section, we considered large areas of study in the psychological sciences that demonstrate how particular geometric characteristics, such as curvature, can be emotively more pleasurable for human beings to observe. This essential nature has been discussed and formalized philosophically since at least the 18th century (see Hume, 1757/2017), and modern theorists continue in this line of reasoning attempting to dissect the enigma of aesthetic experience. Arnheim (1954) proposed that the visual senses are the primary sources of reasoning, perhaps more important and primal than the comprehension of language. Arnheim argued that the visual arts were not so much expressions of an abstract creativity but rather other forms of reasoning: There is an inherent logic in the creation of form, with its exploration and development as essential aspects of the nature of the human animal. Given this narrative of form analytics, we propose it be extended to include an investigation of the history of ideas and cultural changes.

Iconographic Historical Approach

A historical approach must be considered for this exercise, as we relied on antecedently defined historical categories. The goal of creating a model that represents both historical changes in form expression and categories of emotive human experience, such as awe and excitement through form, demanded us to look for the semantic meaning in form. Within art history, this approach can be considered iconographic, where specific formalisms give way to social context and the

overall cultural meaning of the work (D'Alleva, 2005). This approach principally followed the logic of art historian and theorist Erwin Panofsky, who argued that the form of a work cannot be isolated from its content. In his work *Studies in Iconography* (1939), Panofsky defined three levels of analysis that we used to assist our examinations of form and the built environment and to align the literature strands we were exploring: (a) identification of formalisms within the work; (b) identification of key characteristics, motifs, or representations that, traditionally in art history, may be a known story or myth; and (c) the deciphering of meaning within the work considering time, place, and cultural elements. Panofsky was greatly influenced by the German philosopher Ernst Cassirer (cited in Barash, 2008), who argued that images, both physical artifacts and artistic works, have a deep symbolic value that act to document aspects of civilization and culture. Formalism was also important to consider because our analysis relied on the identification of specific compositional elements. However, this principally was used to situate the examples of analytical value within the appropriate artistic genre; this position within art history has been defined as moderate formalism (Zangwill, 2001). Our method involved both the identification of sets of formal properties (i.e., the archetypes described earlier) and an analysis of what these qualities mean culturally, semantically, and emotively.

Reed Kostellow's Principles of Composition

Design theorist Rowena Reed Kostellow (cited in Hannah, 2002) studied the structural makeup of visual relationships in sculpture and industrial design and proposed an influential model for establishing the most critical elements within a form composition. Our methodology was influenced by her compositional theory, and we applied it directly to establishing the important elements of a designed object within the paradigm of an iconographic analysis. Reed Kostellow's compositional theory split form and structural elements into three categories: dominant, subdominant, and subordinate elements, defined by size and visual weight. Compositions of abstract geometry help to illustrate what is meant by the distinct elements (see Figure 6). These relationships between the dominant, subdominant, and subordinate elements were crucial for the

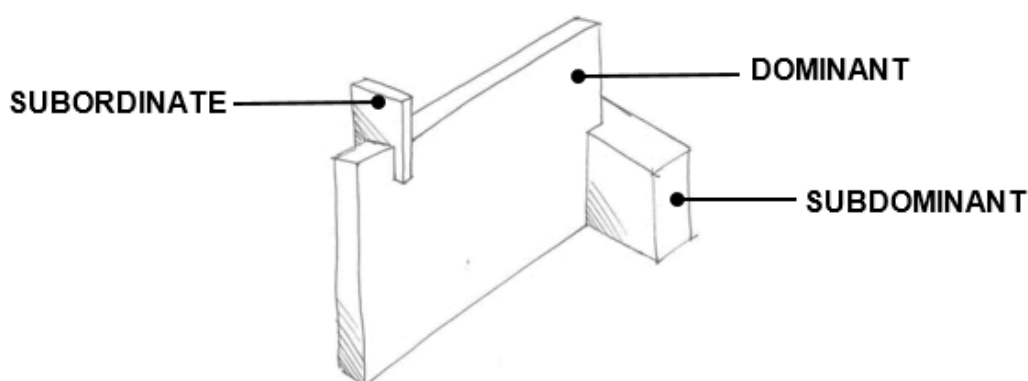

Figure 6. Reed Kostellow's form classifications showing the dominant, subdominant and subordinate forms in a hypothetical composition (adapted from Hannah, 2002). The dominant form is typically the largest of the focus of the composition. The subdominant and subordinate elements are typically smaller or away from the visual center and are used to frame and visually balance the dominant elements.

development of our model and allowed us to trace the importance of specific form motifs through time. While nearly all movements of art, design, and architecture incorporate a large range of geometric manifestations, it remains the case that certain geometric features can be identified as more compositionally important through size and visual weight—dominant, in Reed Kostellow’s terminology. The cuboidal angularity of high modernism is a good example.

Isolation of Points and Lines

Our approach used the analysis of images, where the most important form relationships were highlighted using superimposed lines following Hann’s (2012) and Arnheim’s (1954) respective theses: the line as the basis of structure from which geometric shapes flow and shape as the foundation of form experience. We used broad black lines to outline the dominant structural visual elements, and thinner blue lines to outline the subdominant or subordinate elements, following the Kostellow Reed’s (cited in Hannah, 2002) design compositional theories. This method allowed us to identify archetypal elements of form and structure and ultimately formed the basis of our model. Eleven prominent movements in Western art, architecture, and design encompassing the last three centuries were considered for our visual analysis: neoclassicism, Gothic revival, art and crafts, art nouveau, early modernism, art deco, mid-20th century modernism, brutalism, functionalism, high tech, and postmodernism. Sets of examples were amassed using an iconographic approach by examining the literature focusing on these specific historical periods and considering their key defining traits or archetypes.

Open-source image resources and personal photographic endeavors for finding and documenting appropriate examples were used because it was deemed the most efficient approach to acquiring and examining many types of forms. Keyword Internet searches were conducted using terms such as “neoclassical architecture” or “mid-century modern design” to isolate relevant sets of images and personal photography. Our primary focus was the built environment so the majority of the examples were either architecture or industrial design. Paintings were sometimes included to examine the nature of an art movement more directly. For the set of 11 aesthetic categories that we deemed historically influential, 30-40 images were amassed per historical periods following our guidelines for form and structural archetypes. From this initial set, 20 were chosen for the more detailed stage of analytics. The first phase of this is illustrated in Figure 7, where the key structural features of a built object—in this example, a brutalist building—are identified and marked manually (free-hand) on the image. The marking method followed our predefined form and structural archetype criteria and Reed Kostellow’s composition principles (see Hannah, 2002) detailed earlier.

Following the manual identification process, the important form relationships were processed digitally. This digitization allowed for a clearer representation of the form structures and allowed us to view the geometric elements in isolation, which facilitated our undertaking of the iconographic historical analysis. Figure 8 shows an example of the process of digitizing the manually assessed image. As shown, the critical form features were highlighted. From this point, we could isolate the form features even further as shown on the right.



Figure 7. Manual identification stage where images are superimposed with line. In this image lines are being superimposed upon an image of an example of brutalist architecture which dominated architectural design in the 1970s and 1980s. The key dominant features are being picked out through visual inspection of the image.

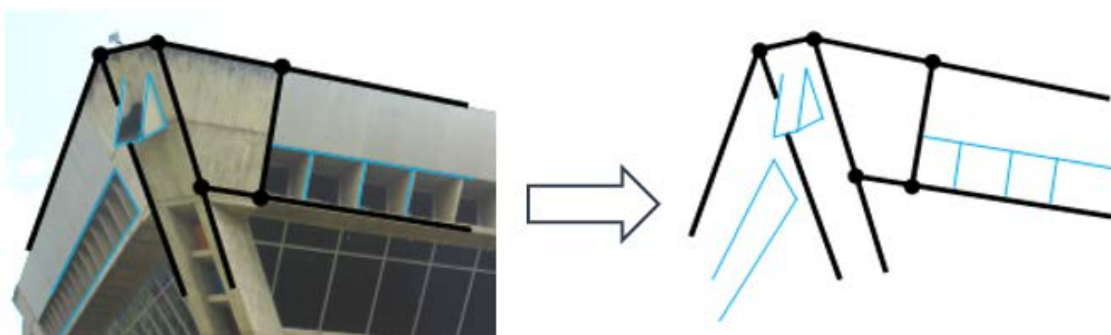

Figure 8. Isolating points and lines where the lines are digitally superimposed atop of an image allowing the line relationships to be revealed in more detail. Following from the manual identification stage, this example from the brutalist architectural tradition was gradually abstracted into sets of line relationships. The black heavier lines represented the dominant features and blue was used to represent subdominant or subordinate features.

Note. Original image includes photo by Liliana Amundaraín from Caracas, Venezuela ([1] (<http://creativecommons.org/licenses/by/2.0>)], via Wikimedia Commons & [https://commons.wikimedia.org/wiki/File:Campo_de_Carabobo_\(1\).jpg](https://commons.wikimedia.org/wiki/File:Campo_de_Carabobo_(1).jpg))

Integration with Emotional Experience

From the analysis using line abstractions, we could see how particular characteristics helped define specific art or design movements, underscoring how form relates strongly to emotion and semantic meaning at the level of experience. The final stage in the methodology was to relate these raw geometric elements with emotional experience and delve deeper into the historical context of the examples we were examining. Figure 8 is a typical example of Brutalist design, and it could be determined that its emotive associations are likely to be semantically negative (i.e., generating negative emotions such as frustration or anger) based on its high dynamic angularity, in line with prior research (see Bertamini et al., 2016; Collier, 1996; Palumbo & Bertamini, 2016; Poffenberger & Barrows, 1924). This information allowed

us to build the subsequent line model of form and emotion presented later. The following sections articulate the methods in greater detail by considering four examples—two with dominant curved forms and two with dominant angular forms.

Curvature

Figure 9 displays examples from the neoclassical tradition that dominated Europe from the mid-18th century until roughly the mid-19th century (Bietoletti, 2005). The movement is a reinvention of the classical styles typical of the ancient European civilizations such as the Greeks and Romans. When we abstracted the structures into line relationships, we identified several notable features. Firstly, the forms were highly precise and had been designed, following Vitruvian standards, to exact proportional rules such as the golden section (i.e., two visual elements may have a golden section if their ratio is the same as the ratio of the sum of the larger of the two elements), which some have argued is, aesthetically, an innate design preference for human observers (Doczi, 1981). Curvature had a more dominant role in the structures; angularity was used to order and frame the designs. This seemed to be a design archetype because these structural features were repeated many times. During the neoclassical period, which ran concurrently to the period now referred to as the Enlightenment, Europe experienced an outpouring of industrial, scientific, and philosophical advances that would eventually culminate in much of modern Western culture (Zafirovski, 2011). This, coupled with a shift in aesthetic output from the visual arts, allowed the grand structures of the period to be realized. One of the central beliefs of the Enlightenment period was that humankind could use the power of reason to control the natural world (Robertson, 2015). This belief helps explain the aesthetic that emerged during the 18th century across Europe and North America. These forms were set within imposing



Figure 9. Neoclassical architecture and decoration showing various neoclassical motifs including organic imagery and use of proportion and symmetry highlighted by superimposed lines (18th & 19th century). The left image shows decoration surrounding a neoclassical style window, the middle an ionic style pillar, and the right image a piece of building ornamentation. In each image the dominant form features are represented with superimposed black lines, the subordinate or subordinate features with blue lines, and visual motifs or representations with dotted boxes.

Note. Original art includes sources from (a) photo by Wolfgang Moroder, https://commons.wikimedia.org/wiki/File:Ala_Napoleonica_Procuratie_dettaglio_centrale_finestre.jpg (b and c) free to use images: <https://pxhere.com/en/photo/612657> and <https://pxhere.com/es/photo/600775>

structures and presented a strong sense of visual order. Organic forms that aesthetically relate to the natural world were apparent, but they were subordinate to the dominant, inorganic structures surrounding and framing them. Ornate sculpture (another archetypal feature of neoclassicism highlighted with superimposed dotted boxes) also is nearly ubiquitous in design of this period. From an iconographic point of view, this work was abounding with symbolic meaning, often incorporating representations of classical myths or historical events triumphed by the people of a certain place or culture. Our use of line abstraction revealed extensive use of ordered curvature in the underlying structure. Significantly, architecture and design from the neoclassical period is often semantically associated with traditional ideals of beauty, order, and elegance (Bietoletti, 2005).

Art nouveau, which was a design movement beginning roughly at the end of the 19th century, has many structural similarities to neoclassical art and is notably dominated by curved forms. Principally, it stood in opposition to academic art, a style that had become associated with the French academies of painting that were favored across Europe (Duncan, 2001). Aesthetically, the art nouveau style is characterized by the frequent use of organic themes and symbolism, features we would argue are archetypal. In some ways, art nouveau was an early use of what is now called biomimicry or biomimetics, with the explicit use of forms found in nature serving as design inspiration (Benyus, 1997). As can be seen in the examples shown in Figure 10, there is almost no use of straight lines, and academic use of proportion appears not to be considered strongly. Curvature dominates both the underlying structures and the forms themselves. The movement overall had strong emotive, semantic, and symbolic characteristics (Raizman, 2003). As a rejection of the academic nature of art at the time, the artists and designers of art nouveau found inspiration in the nonrational, nonlinear world of nature, often explicitly employing plant and flower motifs and asymmetrical and undulating lines (Howard, 1996).



Figure 10. Art-Nouveau art, architecture and design showing unorthodox uses of proportion and highly organically inspired decorative motifs highlighted by superimposed lines (late 19th century). The left image shows a decorative pattern design, the middle interior architecture and the right a household utensil. In each image the dominant form features are represented with superimposed black lines, the subordinate or subordinate features with blue lines and visual motifs or representations with a dotted box.

Note. Original work includes (a) Walter Crane [Public domain], via Wikimedia Commons, https://commons.wikimedia.org/wiki/File:Swan_and_Rush_and_Iris_wallpaper_Walter_Crane.jpg (b) photo by Hans A. Rosbach (Own work) [CC BY-SA 3.0 (<https://creativecommons.org/licenses/by-sa/3.0/>)] sourced from pxhere.com and (c) sourced from <https://pixabay.com/en/carafe-art-nouveau-glass-mug-1346661>

Angularity

Modernism became one of the widest spread and most influential aesthetic and philosophical movements in art and design of the 20th century, with manifestations in architecture, industrial design, music, painting, and many others. Particularly within architecture and industrial design, the modernist aesthetic has notable coherence. The examples shown in Figure 11 are paradigmatic cases of early modernist design. To use Reed Kostellow's guide (cited in Hannah, 2002), the dominant and subdominant structures within the modernist designs can be identified. These designs follow careful grid structures creating dominant vertical and horizontal box forms that frame other box forms. Considering the forms iconographically, they all interplay with a sense of logic and coherence. The modernist philosophy was a radical rejection of many of the prevailing ideas that came before, specifically the notion of representation and ornamentation, often expressed explicitly within the manifestos of the time (see, e.g., *Ornament and Crime*, Loos, 1913/1976). An antecedent of this can be seen in the work of the impressionist and postimpressionist artists of the 19th century, where exact representation according to visual perception was radically challenged (House, 2004).

The modernists were pioneers of abstraction: Complexity did not have to be represented by intricate form, but rather abstracted and viewed from multiple perspectives at once (see, e.g., the work of the Cubists). We argue that it is this quality of abstraction and simplicity that provides Modernism with its aesthetic coherence and is its principal archetypal quality. While there are exceptions—the art of Kandinsky or Picasso, for instance, can be viewed as highly complex and intricate—a quality of abstraction is consistent, and a type of geometric reductionism to simplicity and isolation led to the loss of subject recognizability (Dickerman & Affron, 2012).



Figure 11. Modernist architecture and painting showing dominant use of angular forms highlighted by superimposed lines (early 20th century). The left image shows a house within the Weissenhof Estate designed by Le Corbusier, the middle the Bauhaus school building in Dessau designed by Walter Gropius and the right early abstract art by Piet Mondrian. In each image the dominant form features are represented with superimposed black lines, the subdominant or subordinate features with blue lines.

Note. Original work includes (a) photo by Andreas Praefcke (Self-photographed) [CC BY 3.0 (<http://creativecommons.org/licenses/by/3.0>)] and sourced from pxhere.com (b) sourced from <https://pxhere.com/en/photo/1110518> and (c) photo by Piet Mondrian [Public domain], via Wikimedia Commons, https://commons.wikimedia.org/wiki/File:Composition_A_by_Piet_Mondrian_Galleria_Nazionale_d%27Arte_Moderna_e_Contemporanea.jpg

Dominant angularity and heavy use of positional form structures are archetypal features of modernism, particularly within industrial design and architecture. Additionally, the buildings and products of the modernist movement are highly proportioned and ergonomic, expressly designed for use by human beings, tailored to human needs, and a bit machine-like (Smock, 2009). Abstraction was the critical component of the movement generally; it could be argued, for instance, that modernist buildings are abstract versions of the preceding neoclassical. Modernist buildings lack what Arnheim (1954) described as dynamic obliqueness, meaning they appear very stable and structured. Through a process of line abstraction, we saw that the designers associated with the movement were interested in arrangements of right angles and cuboids. Functionalism was the central belief of modernist design; aesthetics was viewed as secondary to the utility of the building or the product. Possibly the greatest exponents of the tradition, the Bauhaus school in Germany (1919–1933), were instrumental in developing this approach. Abstraction was taught to be appreciated and that products could achieve a certain quality of functional elegance through a radical philosophy of simplicity and modernization (Droste & Bauhaus-Archive, 2002). Modernism is a direct descendant of the rationalism that was implicit within neoclassical styles, while simultaneously being a rejection of its traditionalist and academic values (Pevsner, 1960). The central difference between modernism and neoclassicism is modernism took forms to high levels of abstraction, ostensibly devoid of symbolic meaning and cohering around a philosophy of brute functionalism and where the social and philosophical changes in society directly translated into a shift in aesthetics (Greenhalgh, 1990). One could posit that design utilizing controlled angularity is a semantic representation of utility, functionality, and order.

Mid-century modernism followed on the traditions associated with the first modernists with noticeable differences in form and structural output. Analyzing the work of North American design provided an important insight into the aesthetic and cultural shifts that took place. Technological development in manufacturing during the 1940s (largely stimulated by the onset of war) presented a new scope for form experimentation in product design as the mid-century beckoned. Abstracting the forms into their underlying line relationships, both the presence of curvilinear and angular structural relationships, both equally strong as structural elements, became clear (Figure 12). The development of mass-producible plastics meant curved structures could more simply be applied within a product context. Additionally, we propose that these new, arguably more organic, forms are a reaction against some of the functionalism of early modernist tradition that perhaps seemed too dogmatic. During this time, the United States and many areas of Europe were experiencing a counter-culture movement. This new hippie culture manifested itself in industrial design and architecture by the presence of more sweeping curves, bulbous forms, and brighter colors. A small sample of work from the Eames', Raymond Loewy, Greta Grossman, Eero Saarinen, the Finnish, Nordic, and Danish design schools clearly demonstrates this aesthetic trend. The forms were more emotionally resonant with the inclusion of generous curves; they were less intellectual by not adhering to a doctrine of strict functionalism and were mass marketed to consumers (Quinn, 2004). While these designers were not explicitly part of the counter-culture movements, we argue that the broad changes in society—specifically in culture and politics—had a tangible, emergent effect on form expression among professional designers. Following the logic of Deleuze (cited in Quinn, 2004), where the expression of form is always connected to the world of the political,



Figure 12. Mid-century modern design and architecture showing the inclusion of generous curving features and less use of dominant angular features highlighted by superimposed lines (mid-20th century). The left image shows an iconic chair by Charles and Ray Eames, the middle architecture by Alvar Aalto and the right architecture by Arne Jacobsen. In each image the dominant form features are represented with superimposed black lines, the subdominant or subordinate features with blue lines.

Note. Original work includes (a) Photo by Rama, Wikimedia Commons, Cc-by-sa-2.0-fr [CeCILL (http://www.cecill.info/licences/Licence_CeCILL_V2-en.html) via Wikimedia Commons https://commons.wikimedia.org/wiki/File:Eames_chair-IMG_4624.jpg (b) Photo by J.-P. Kärnä [CC BY-SA 3.0 (<https://creativecommons.org/licenses/by-sa/3.0>) via Wikimedia Commons https://commons.wikimedia.org/wiki/File:Helsinki_University_of_Technology_auditorium.jpg and (c) photo by Christian Lylloff (Own work) [Public domain], via Wikimedia Commons https://commons.wikimedia.org/wiki/File:Arne_Jacobsen_benzintank_Moerke.jpg

we state that the designs of the mid-20th century did, in some ways, reflect the liberalization of culture that was taking place and the renewed emotional optimism and progressivism of post-war America and Europe (Kaplan, Tigerman, Adamson, & Los Angeles County Museum of Art, 2011).







Summary of Analysis





Line, it has been shown here, is a powerful tool for analysis. The examples illustrate the relevance of this approach. By applying a line abstraction, the underlying structure of the form can be revealed partially. While only four historical genres of design were detailed here, we analyzed 11 in the process of this research. Going through each one here, however, would have been a tedious exercise for the reader. From here we have categorized commonly seen form characteristics and archetypes, the known historical movements, and the empirically acquired emotive and semantic relationships following the historical analysis described in the preceding paragraphs and the visual perception work from Poffenberger and Barrows (1924), Collier (1996), Bertamini and others (2016), and Mothersill and Bove (2015). This is summarized in Table 1

THE LINE MODEL OF FORM AND EMOTION

Our methodology of line abstraction and art-historical analysis allowed us to probe the meaning and the emotive layers of form through an iconographic historical approach. The model, shown in Figure 13, is presented as a flowing line. Inspired by Hann (2012) and Poffenberger and Barrows (1924), we present the line in a form similar to a sinusoidal wave that varies in frequency and structure. There is no start or end necessarily; the line should be viewed as a continuum in the same way emotional experience is both constant and changeable (Dewey, 1934). The model was

Table 1. Summary of Form Characteristics, Emotive Experience, and Semantic Connotations of 11 Western Aesthetic Movements since Approximately 1750 AD.

Dates	Form Characteristics	Emotive Experience	Semantic Connotations	Common Form Features
NEOCLASSICISM				
1750s onward	Dominant curved forms framed by precise angular forms. Frequent use of symmetry and organic and symbolic forms	Peace, calm, awe	Romantic, organic, beauty, strength (Bietoletti, 2005)	
GOTHIC REVIVAL				
1750-1860	Dominant use of curves and angularity. Frequent use of symbolic and organic forms – highly complex	Awe, amazement	Power, authority, prestige (Frankl & Crossley, 2000)	
ARTS AND CRAFTS MOVEMENT				
1880-1910	Dominant organic and curved forms. Frequent use of floral imagery	Peace, calm, happiness	Organic, floral, decorative, romantic (Blakesley, 2006)	
ARTS NOUVEAU				
1890-1910	Dominant organic and curved forms. Frequent use of floral imagery and symbolism	Peace, calm, happiness	Organic, floral, decorative, romantic (Howard, 1996)	
EARLY MODERNISM				
Approx. 1900 onward	Dominant angular forms, highly precise. Some use of curved forms. Little use of symbolism	Serenity, calm, pensiveness,	Functional, utilitarian, simple, rational (Pevsner, 1960)	
ART DECO				
1920-1940	Frequent use of angular and curved forms. Frequent use of symbolism	Intrigue, awe, agitation	Vibrant, geometric, organic (Bayer, 1999)	
MID-CENTURY MODERNISM				
1930-1965	Dominant curved forms with frequent use of angular forms	Happiness, calm, serenity	Functional, beautiful, elegant, quiet, smooth (Quinn, 2004)	

BRUTALISM				
1950-1975	Dominant angular forms, little use of curved forms	Surprise, intrigue, frustration	Harsh, authoritative, functional, strange, cruel (Clement, 2012)	
FUNCTIONALISM				
1950 onward	Dominant angular forms, little use of curved forms. Some symbolic value	Surprise, earnestness, tension	Utilitarian, functional, (Bürdek, Dale, Richter, & Hausmann, 2015)	
HIGH TECH				
1970 onward	Use of both angular form domination or curved form domination	Joy, awe, surprise, tension	Technological, precise, organic, rational, structural (Abel, 2004)	
POSTMODERN				
1980s onward	Use of both angular form domination and curved form domination (typically angular). Frequent use of ornamentation	Surprise, confusion, intrigue	Geometric, strange, juxtaposed, comedic (Kolb, 1992)	

Note. Table presents a summary of historical movements in aesthetics charting characteristics, emotive, and semantic connotations with line abstractions. The semantic connotations have been considered with reference to art history scholarship. The form features or archetypes have been derived from the line abstraction method.

developed iteratively until we were satisfied that the range of line abstractions of form we investigated was suitably represented. Naturally, all the movements in aesthetics from recent history could not have been considered; this was beyond the scope of this research. Nevertheless, our research has generated a picture of the more influential movements in the Western aesthetic tradition.

Features of the Model

The line model of form and emotion has distinct features that bring together several narratives from form, emotion, and semantic theories in the visual arts and, in particular, design. The model considers four key aspects:

- (a) emotive and semantic qualities related to form categories
- (b) the embodiment of these qualities with aesthetic movements across recent history (form and structural archetypes)
- (c) form as a representation of information
- (d) the intensity of the emotive and semantic values.

Resulting from our review of the previous studies in form perception, a great deal of evidence suggests a dichotomy of perception, that is, curvature versus angularity relating to

positive versus negative emotional states respectively. While actual cognitive processing of form is much more complex, dichotomy of perception presented a good starting point. We therefore split the model into two halves, respectively displaying curved geometric continuities transitioning into angular continuities (see Figure 13).

DISCUSSION

Lines of Emotion and Historical Transitions

One of the central themes of the model is the psychological experience of emotion. We reviewed some of the critical research into emotional experience and categorization and have used it to inform our model. Importantly, we have considered the work of Plutchik (1980, 2001), who recognized the inherent complexities of human and animal emotion and the difficulties in supplying absolute definitions and categories. His models describe emotional states that have a certain fuzziness. Joy, for example, is composed of aspects of love and optimism and, in turn, stands between serenity and ecstasy in terms of intensity. This relates to the experiential qualities of emotion that are multifaceted, complex, and challenging to define unequivocally (Scherer, 2005).

In the line model, drawing on the order of emotional character and intensity as defined by Plutchik (1980, 2001), joy does not stand alone; it is changeable and dependent on other experiential qualities like optimism. Similarity between emotional experiences in terms of their character, feeling or intensity is also a point of interest. Although a good deal of difference exists between joy and anger in terms of intensity and composition, it is more challenging to distinguish between anger and hostility or disgust and surprise. These emotive distinctions are illustrated on the model where joy, for example, is placed above a large curve and is assigned a high degree of intensity. The same can be observed for rage on the angular end of the model. These emotions are driven by more intense states of arousal and, as Coates (2003, 2014) noted, contain more visual information (i.e., edges, corners, or changes in directionality), making them more challenging to cognitively process.

The changing nature and nonlinearity of emotional states when observing art, buildings, and objects are the points we intended to convey with this model. Although there is some experiential stability, the context of form can lead to dynamic emotive associations. As the line flows, emotions flow with it. When humans encounter structure, they are also encountering states of change and the dynamic forms of experience and perception described by Dewey (1934) and Arnheim (1954). The holistic thought of the Gestalt also is relevant where visual experiences of form and the relationships between elements are processed as a whole and assigned meaning before being broken down in the mind. Sometimes this meaning is understood through culture or a social context, and sometimes through innate preferences and psychological drives. Angular forms have some connection to aesthetic conceptualizations of nervousness and fear, but their association with rationalism may be a gradual cultural construction derived from the principles of engineering and functionalism.

Connection to the historical past and the history of ideas is a fundamental component of the model. Its visual information conveys form structures associated with clear aesthetic movements within the history of art, architecture, and design. The model was developed using

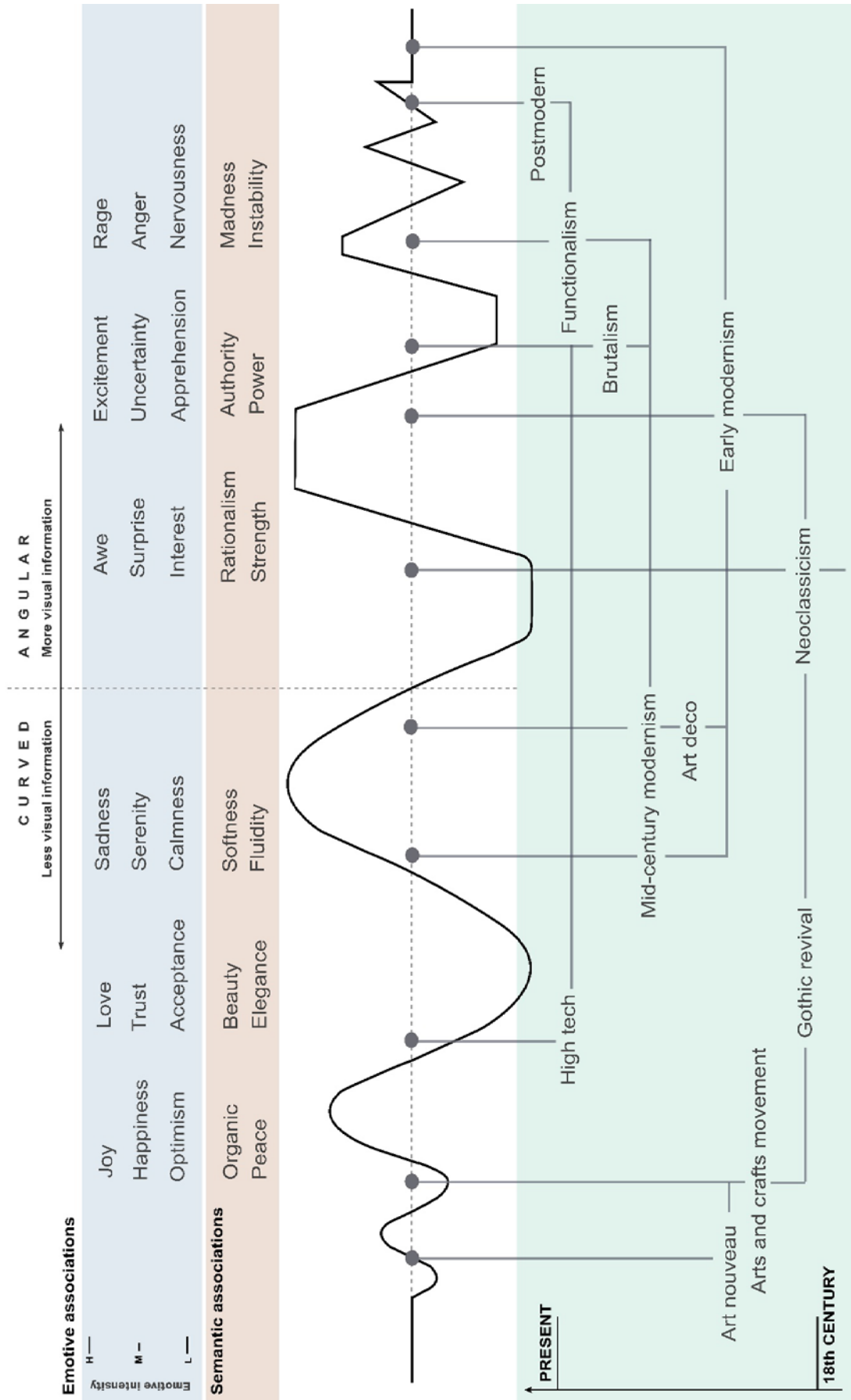

Figure 13. The line model of form and emotion. The top half details the emotive and semantic connotations of the line form; the bottom half considers the historical changes in form across time from roughly the mid-18th century until the present day. The emotive categories highlighted at the top are derived from Plutchik (1980), Shaver et al., (1987) and Cowen and Keltner (2017).

the iconographic approaches developed by Panofsky (1939), where compositional form elements are examined structurally and then in terms of semantic meaning, thus establishing relationships between the forms and the visual experience of observers. Importantly, the historical movements examined within the model show no linear path in form evolution and no clear inevitability. We argue that some features of form and structure can relate to societal feelings and philosophies, but the diversity of thought within artistic and design practices make them very difficult to pin down in an absolute sense. Although modernism can lead to its mid-20th century variant, which was thematically and philosophically similar, the same is not seen in the transitions from art nouveau to modernism because the underlying philosophies were very divergent. Our model clearly demonstrates this divergence in the dominant styles.

The movements are placed in the model on a time scale that spans from roughly the beginning of the 18th century to the present. When lines intersect the central axis of the line model (Figure 13), this indicates that the surrounding line abstractions are the archetypal form features of a particular movement. For example the brutalist and functionalist movements intersect at points where the line is highly angular. The complexity of some movements—art deco, for example, which incorporates both elements of angular form and curvilinear form dominantly—is indicated by intersection with multiple points of the model. The connections between and among the various aesthetic movements become more apparent when applying our model. If there is one root from which many of the modern and contemporary movements come, it is arguably the neoclassical tradition. Due to its dominance in Western art, architecture, and design, the movement has exerted a profound influence on subsequent work, both aesthetically and philosophically (Bietoletti, 2005). While early modernism strove toward a radical abstraction, it still adopted the structural underpinning of the neoclassical traditions. Contemporary high-tech architecture, also known as structural expressionism, includes both curves and angularity in a wide variety of forms. Although this movement has been abstracted from its initial roots in the neoclassical and classical traditions, the core semantic message of achieving beauty through the principles of reason remains. Our line abstraction method has allowed us to reveal these relationships with greater clarity.

Additionally, technological advance is a critical element that has not been directly considered within the context of the model but much of the tangible aesthetic shifts we considered have been influenced by these changes. Indeed, it has been argued that the constraints of available manufacturing technology are a significant influence upon the final form of a product (Crilly, Moultrie, & Clarkson, 2009). Therefore, form development may be a function of emotional needs and socio-semantic reasoning fused with structural preferences, technological capability, and clear functional requirements. The novelty of certain aesthetic movements may come from a coherence in form and structural archetypes that allows for more stable emotional engagement.

Relevance for Design

How can this work advance contemporary design practice, be it product, architectural, or technological? While this model, in its current iteration, is theoretical and draws upon a variety of sources to advance the arguments, it can provide some tangible insights. Firstly, the model is significant for design practitioners wanting to create more emotionally resonant products. The work of Jordan (2000) set out the relevance for understanding of human factors in industrial

design including aesthetic pleasure and the pleasure derived from using a product. As Jordan (p. 7; italics in original) stated, “Products are not merely tools: they can be seen as *living objects* with which *people* have *relationships*.” This transition from products seen as tools or ornaments to something embodying experiential value is highly significant and can extend to architecture and the built environment. Factors of emotional experience are becoming vital components in modern design practice, as Norman (2004) also noted. Our model, while not dealing with use factors directly, can be used as a guide for aesthetic factors and experiential factors relating to aesthetics, particularly emotion. Within a particular context, a product or architectural structure could be designed with insights from the relationships between emotional experience and form elements. A recent study has in fact suggested that emotionally pleasurable forms can be meaningfully categorized within defined semantic and experiential boundaries (see Chang & Wu, 2007), and another found that form can even convey types of personalities (Desmet, Ortíz Nicolás, & Schoormans, 2008). These are complex relationships humans can have with designed objects, and increased understanding in this area could lead to improved societal well-being. Through our novel form abstraction method, we seek to show the value in a deeper knowledge of emotional experience, categories of emotional experiences, historical change in form expression, and semantic theory. The key benefits of the work and the model in its current iteration to general design practice are summarized here:

- (a) provides to designers critical visual direction as they design products, spaces, or buildings for a category of emotional experience;
- (b) provides examples of how form has been emotionally expressed since the 18th century through the historical breakdown of form development;
- (c) provides designers with a deeper understanding of form semantics when they attempt to configure emotionally sensitive products, spaces, or buildings; and
- (d) provides a heuristic framework to inspire discussion on form and emotion.

Limitations of the Model

The line model of form and emotion presents a theoretical synthesis of information and it is important to discuss its limitations at this stage. Our model is not traditionally empirical due to the lack of a direct study, but we sought to discursively bring together a wide variety of literature in a novel approach to distinguishing form characteristics. We stress that this model is theoretical, is in its early stages of development, and must be advanced and refined through future research. Currently it can be used as a visualization tool for designers, but it provides, in this initial iteration, an incomplete picture. A more systematic and empirical approach may validate the model through psychological studies, a point when other research efforts can add to the ideas within this work. We suggest utilizing our line abstraction methods in a more systematic way. Future scholars could analyze larger arrays of images and create more refined categories of forms. Or perhaps, they could use sets of line relationships derived from abstraction approaches and psychologically test them. Two critical aspects that were not considered in this analysis are material properties and color. The model does have a central focus on form abstractions, but future research could consider the material aspects of design and architecture. For instance, what are the emotional differences between experiencing a sandstone building and one made from glass or steel? Would there be a difference between

experiencing a brightly colored object as opposed to one of more muted colors? These are interesting questions that our model does not yet answer. Adding these dimensions to the model would be valuable for both design practitioners and future researchers.

One important concern is that the model currently is limited to European and North American cultures. The influential artistic movements from Asia, Africa, South America, and the Middle East are not included in this iteration of the model. Further work must consider these movements in providing a more complete picture of form development paired with emotional experience across time. For instance, the aesthetic of traditional Japanese interiors was a major influence on Western modernist architects (Tanizaki, 1933). Including all of these movements was simply beyond the scope of this paper, but future iterations of the model could and should map these aesthetic histories. Visually comparing the differing stories of Eastern and Western art may be a useful tool for scholars examining parallel periods in history.

Additionally, the model does not capture the variety implicit within the movements. We made generalizations that are useful for understanding the key form trends and relating them to emotion or philosophies of a particular time. Modernism, for example, was dominated by rigid and angular forms but was never confined to this; the modernist philosophy also was expressed through other geometric endeavors. We suggest that the coherence of modernism as an aesthetic depends on abstraction and the angular symbols of functionalism. For this reason, our model could be considered too reductionist.

Further, our method of abstraction also needs some scrutiny. While we used well-developed theories of composition to break down our examples and followed the logic of Hann (2012), who defined the foundation of all geometry as coming from points and lines, we acknowledge that compositions can be broken down in alternative ways. An example could be applying discrete sets of whole shapes.

Finally, other methods of art history could have been explored, such as pure formalism or Marxist analytics, which would consider social and class dynamics as the axis by which artistic developments move (D'Alleva, 2005). Either of these movements may have proved valuable, but our iconographic approach appeared the most suitable due to its method of analyzing critical aspects of both form and culture, which can subsequently be examined from the perspective of emotional experiences.

CONCLUSIONS

Following an examination of form theory and the models of design and emotion, we developed an initial iteration of the line model of form and emotion. Taking inspiration from various sources—including early and more recent work in experimental aesthetics, psychologists of emotion and experience, the Gestalt theorists, art and design historians, and modern work in semantics—we built a general model of abstract form relationships connected with emotive and semantic values. From this, we illustrated how form evolution is a nonlinear, organic, and highly dynamic process with many variations across recent history that can relate to a wide variety of emotive states and semantic values. The model is incomplete in its historical analysis and would benefit from further development, but we have tried to include the most historically influential movements within Europe and North America.

With respect to this, we hope this model can be used as a point of reference for designers or architects interested in creating emotionally rich objects. Additionally, we hope it can be used as a heuristic tool for inspiring discussion around form, aesthetics, and emotion. There is a requirement in contemporary design—architectural or industrial—to emotionally engage with users, to offer the user a specialized emotional experience. The model supplies clear information regarding the emotive and semantic connotations of form and helps place form in a particular historical and cultural context.

These conclusions also open the door to further questions. Can these ideas be successfully applied in actual design practice? What are the implications of considering form in this abstract way? Can these methods enhance understanding of the history of the visual arts, design, and architecture more effectively? The line model of form and emotion provides a starting point for further studies to explore our arguments and conclusions on the experiential, emotional, and semantic qualities of form. There are a number of implications of the work that this section will look at in more detail; three areas where this research could possibly be applied and expanded. Firstly, the expanding field of user experience design and design emotion, secondly, design and art education and theory, and thirdly, creative practice generally.

Future User Experience Design

In this article, we explored a number of avenues of scholarship but were primarily concerned with the emotional value of form and how this can manifest in designed objects, works of art, or architecture. Multiple researchers, including Desmet (2003), Hekkert (2006), Crilly, Moultrie, & Clarkson (2004), and Crilly et al. (2009), have explored, and others have applied, this thinking to create new modes of user experience. Work by Niedderer (2012), for instance, designed a novel fruit bowl in silver using symbolic representations of emotion and soma-semiotic interpretations of movement. The bowl was explicitly designed to elicit an emotional response based on its form, which was based on curves and its interaction properties. Overall, the bowl was described as joyous by participants in a series of visual and tactile tests. This sense of representation through form is becoming more explicit in design and can be seen directly in the work of artist and designer Ane Christensen, who is inspired by feelings, sensations, and movement. Her Kinetic sculptures explore concepts such as symbiosis and connectivity. Similarly, the work of designer Thomas Heatherwick has contributed to several radical form-driven architectural projects, such as the Seed Cathedral. It certainly seems that the modernist ideal of beauty through utility, though influential, is being questioned, and our research contribution may help others to anticipate what the future may hold for designed objects and the built environment.

Ultimately, understanding that particular forms or geometric relationships can inspire very negative or very positive emotions may influence the way products are created in the future. The digital world must also be considered here. Computer interfaces have paved the way for designers' ongoing concern for emotional experience in design generally (Cooper, 1999). Yet computer systems will evolve to become more immersive, meaning that the emotional experience of users will become even more important. At a more complex level, virtual reality gaming, for instance, offers a new world of sensory experience for which well-designed aesthetics will be critical for users. A good understanding of form and emotion, and indeed the history of form, may bring the most resonant emotive experiences for users. Symbolically capturing a sense of excitement, fear, or joy through various aesthetic techniques is something

that is already practiced within film media (Plantinga & Smith, 1999), but the immersion of virtual reality may need a more considered and layered set of form motifs and archetypes. At a less complex level, virtual reality systems are being developed for various types of software, such as photo and film editing, CAD, and even admin software like email interfaces and data exchange (Whyte, Bouchlaghem, Thorpe, & McCaffer, 2000). The form and structure of these new spaces of human experience must draw upon the best knowledge of form and space, as designers serve as architects in a nonmaterial world.

It is not hard to see how a deeper understanding of experience and emotion can translate into certain rules or standards for designers, standards explicitly detailing how product forms or digital environments can be configured for higher degrees of user enjoyment. Additionally, there is opportunity for using advances in emotional design research to benefit the environment. Design academic Jonathan Chapman (2005) argued strongly that the products created should be more emotionally durable and constructed in such a way as to decay and change meaningfully. Chapman (2005) pointed out, for example, that a ripped pair of jeans, a stained T-shirt, or a scratched phone casing has a kind of value, one drawn for its use and interaction with a person over a period of time. Could digital environments also be configured this way? Even the design of packaging could have more emotional resonance and relevance, leading to less waste and new categories of use (Norman, 2004). Small changes to human technological approaches can have meaningful impact.

Design and Art Education and Theory

This paper is principally building towards a new theory and it is worth examining how it could potentially be applied within design and art education. Although in-depth discussion of how design and art education is structured across the Western world is beyond the scope of this paper, the topics constitute various approaches and methods, including iconographic (as applied in this work), formalist, and sociological approaches (D'Alleva, 2005). Future education programs could include the psychological analysis that has been used throughout this work. While recognizing the symbolic power and value of form is paramount within the analysis of aesthetics, the tangible and measurable psychological or neurological affects have received only limited consideration (Silvia, 2005). If students of art or design were more attuned to the wealth of scientific evidence relating forms to emotional experience, it could offer new avenues of study and creative expression.

In terms of the theoretical implications of this work, a few points warrant consideration. Firstly, the attempt to map how form has changed across time offers new avenues of interpretation for researchers. Integrating the history of ideas, semantics, emotion psychology, and the study of artifacts may lead to a wealth of new theory from future researchers. Secondly, this work challenges the idea of the artist, designer, or creator as the sole arbiter of his/her work. Our analysis leads to a much more complex conclusion, where designed objects, art, or architecture is a function of multitudinous interactions of beliefs, practices, materials, needs, and meanings, as Forty (1986) broadly iterated.

Creativity and Form Expression

Finally, it is important to consider the value of this work for the practice of design, art, architecture, or urban, interior, or graphic design. The line model could be used for creative

purposes and as a heuristic tool to stimulate discussion around form, but other options could be explored that apply the model more directly as a design tool. Mothersill and Bove (2015) developed a CAD tool (i.e., the EmotiveModler) for configuring emotively expressive forms. Taking cues from their work, the line model could be applied in a similar way and digitized for direct use in CAD software. Elements within a model could be analyzed for emotively resonant features and forms. Relating back to the discussion of positional, tangent, and curved line continuities described earlier, these could be given some broad emotive significance and meaning within CAD software itself, allowing designers greater control over form expression. Indeed, the principle could be extended to other areas of digital creativity, for example, graphic design or typeface design. A technology of this kind, however, would require more research and data to be realized.

Although developing the model or its future iterations into a digital analysis tool is possible, computation is another avenue that is being explored within design practice. The interesting work of Neri Oxman (2012), for example, has used the computational rules associated with biology and growth to design seating and jewelry. Information contained in the line model could be applied computationally. Given certain inputs, an emotive design could develop from simple line elements. Currently, this is speculative and beyond the scope of this work but, with future development, many new spaces of creative possibility could open.

IMPLICATIONS FOR THEORY, APPLICATION, OR POLICY

There are several immediate implications this research could have for the wider research community, design practitioners or policy constructors, several outlined in the Conclusions section. Here we presented work in form theory and human emotive responses to form and have argued that this knowledge can be applied in design and architectural practice. In drawing on form theory and human emotive responses to form, the outcomes of this research can support and enhance the emerging work in design emotion. For this research output and others in technological applications, our research can open avenues for better theoretical understanding of form perception but also provide insights useful for designers or researchers focusing on emotive products or aesthetics.

ENDNOTES

1. Form can be defined in a variety of ways, including as a type of something, a procedure, a linguistic operation, etc. In this article, form is defined to mean specifically visual form.
2. In this article, we refer to Western design (also Western world/culture/art) as a design tradition that is practiced particularly in Europe and North America. We acknowledge the attribute Western allows multiple interpretations (see Bavaj 2011), but believe it is accurate enough application in this article.

REFERENCES

- Abel, C. (2004). *Architecture, technology, and process*. Amsterdam, the Netherlands: Elsevier, Architectural Press.
- Ainsworth, T. (2016). Form vs. matter. In E. N. Zalta (Ed.), *The Stanford encyclopedia of philosophy* (Spring 2016 Edition). Retrieved from <https://plato.stanford.edu/archives/spr2016/entries/form-matter/> doi: 10.2307/2021934
- Aristides, J. (2016). *Lessons in classical painting: Essential techniques from inside the atelier*. New York, NY, USA: Watson-Guption.
- Arnheim, R. (1954). *Art and visual perception: A psychology of the creative eye*. London, United Kingdom: Faber and Faber.
- Bachelard, G. (1994). *The poetics of space* (M. Jolas, Trans.). Boston, MA, USA: Beacon Press. (Original work published 1958)
- Bar, M., & Neta, M. (2006). Humans prefer curved visual objects. *Psychological Science*, 17(8), 645–648. doi: 10.1111/j.1467-9280.2006.01759.x
- Barash, J. A. (2008). *The symbolic construction of reality: The legacy of Ernst Cassirer*. Chicago, IL, USA: University of Chicago Press.
- Barbalet, J. (1999). William James' theory of emotions: Filling in the picture. *Journal for the Theory of Social Behaviour*, 29(3), 251–266.
- Bavaj, R. (2011). "The West": A conceptual exploration. *European History Online*. Retrieved from <http://iegego.eu/en/threads/crossroads/political-spaces/political-ideas-of-regional-order/riccardo-bavaj-the-west-a-conceptual-exploration>
- Bayer, P. (1999). *Art deco architecture: Design, decoration and detail from the twenties and thirties*. London, United Kingdom: Thames & Hudson.
- Benyus, J. M. (1997). *Biomimicry: Innovation inspired by nature*. London, United Kingdom: Harper Collins.
- Bertamini, M., Palumbo, L., Gheorghes, T. N., & Galatsidas, M. (2016). Do observers like curvature or do they dislike angularity? *British Journal of Psychology*, 107(1), 154–178. doi: 10.1111/bjop.12132
- Bietoletti, S. (2005). *Neoclassicism and romanticism*. New York, NY, USA: Sterling Publishing.
- Blakesley, R. P. (2006). *The arts and crafts movement*. London, United Kingdom: Phaidon Press.
- Bloch, P. H. (1995). Seeking the ideal form: Product design and consumer response. *Journal of Marketing*, 59(3), 16–29. doi: 10.2307/1252116
- Bürdek, B. E., Dale, M., Richter, S., & Hausmann, N. (2015). *Design: History, theory and practice of product design*. Basel, Switzerland: Birkhäuser Verlag.
- Butler, E. A. (2017). Emotions are temporal interpersonal systems. *Current Opinion in Psychology*, 17, 129–134. doi: 10.1016/j.copsyc.2017.07.005
- Cannon, W. (1927). The James-Lange theory of emotions: A critical examination and an alternative theory. *American Journal of Psychology*, 39(3), 106–124. doi: 10.2307/1415404
- Chalmers, D. J. (1995). Facing up to the problem of consciousness. *Journal of Consciousness Studies*, 2(3), 200–219.
- Chang, W. C., & Wu, T. Y. (2007). Exploring types and characteristics of product forms. *International Journal of Design*, 1(1), 3–13.
- Chapman, J. (2005). *Emotionally durable design: Objects, experiences, and empathy*. London, United Kingdom: Earthscan.
- Clement, A. (2012). *Brutalism: Post-war British architecture*. Marlborough, United Kingdom: Crowood.
- Clottes, J. (2016). *What is paleolithic art? Cave paintings and the dawn of human creativity*. Chicago, IL, USA: University of Chicago Press.

- Coates, D. (2003). *Watches tell more than time: Product design, information, and the quest for elegance*. New York, NY, USA: McGraw-Hill Education.
- Coates, D. (2014). *Advances in affective and pleasurable design*. Boca Raton, FL, USA: CRC Press.
- Collier, G. L. (1996). Affective synesthesia: Extracting emotion space from simple perceptual stimuli. *Motivation and Emotion*, 20(1), 1–32. doi: 10.1007/BF02251005
- Cooper, A. (1999). *The inmates are running the asylum*. Carmel, IN, USA: Sams Publishing.
- Cornford, F. M. (1957). *Plato's theory of knowledge: The Theaetetus and the Sophist*. Mineola, NY, USA: Dover Publications, Inc.
- Cowen, A. S., & Keltner, D. (2017). Self-report captures 27 distinct categories of emotion bridged by continuous gradients. *Proceedings of the National Academy of Sciences of the United States of America*, 114(38), E7900–E7909. doi: 10.1073/pnas.1702247114
- Crilly, N., Moultrie, J., & Clarkson, P. J. (2004). Seeing things: Consumer response to the visual domain in product design. *Design Studies*, 25(6), 547–577. doi: 10.1016/j.destud.2004.03.001
- Crilly, N., Moultrie, J., & Clarkson, P. J. (2009). Shaping things: Intended consumer response and the other determinants of product form. *Design Studies*, 30(3), 224–254. doi: 10.1016/j.destud.2008.08.001
- Csikszentmihalyi, M., & Robinson, R. E. (1990). *The art of seeing: An interpretation of the aesthetic encounter*. Los Angeles, CA, USA: Getty Publications.
- Dalgiesh, T. (2004). The emotional brain. *Nature Reviews Neuroscience*, 5, 583–589. doi: 10.1038/nrn1432
- D'Alleva, A. (2005). *Methods and theories of art history*. London, United Kingdom: Laurence King Publishing.
- Descartes, R. (1911). *Meditations on first philosophy*. Cambridge, United Kingdom: Cambridge University Press. (Work originally published 1641)
- Desmet, P. M. A. (2003). A multilayered model of product emotions. *The Design Journal*, 6(PART 2), 4–13. doi: 10.2752/146069203789355480
- Desmet, P. M. A., & Hekkert, P. (2014). Special issue editorial: Design & emotion. *International Journal of Design*, 2(3), 1–6.
- Desmet, P. M. A., Ortíz Nicolás, J. C., & Schoormans, J. P. (2008). Product personality in physical interaction. *Design Studies*, 29(5), 458–477. doi: 10.1016/j.destud.2008.06.003
- Dewey, J. (1934). *Art as experience*. New York, NY, USA: Perigee Books.
- Dickerman, L., & Affron, M. (2012). *Inventing abstraction, 1910–1925: How a radical idea changed modern art*. London, United Kingdom: Thames and Hudson.
- Dixon, T. (2003). *From passions to emotions: The creation of a secular psychological category*. Cambridge, United Kingdom: Cambridge University Press.
- Doczi, G. (1981). *The power of limits: Proportional harmonies in nature, art, and architecture*. Boulder, CO, USA: Shambhala Publications.
- Droste, M., & Bauhaus-Archive. (2002). *Bauhaus, 1919–1933*. Cologne, Germany: Taschen.
- Duncan, A. (2001). *Art nouveau*. London, United Kingdom: Thames and Hudson.
- Durgee, J. F. (1988). Product drama. *Journal of Advertising*, 17, 42–49.
- Dutton, D. G., & Aron, A. P. (1974). Some evidence for heightened sexual attraction under conditions of high anxiety. *Journal of Personality and Social Psychology*, 30(4), 510–517. doi: 10.1037/h0037031
- Ekman, P. (1980). Facial signs of emotional experience. *Journal of Personality and Social Psychology*, 39(6), 1125–1134.
- Ekman, P. (1992). An argument for basic emotions. *Cognition and Emotion*, 6(3/4), 169–200.
- Ellis, W. D. (1938). *A source book of Gestalt psychology*. Abingdon, United Kingdom: Routledge.
- Feldman Barrett, L. (2006). Solving the emotion paradox: Categorization and the experience of emotion. *Personality and Social Psychology Review*, 10(1), 20–46.

- Forty, A. (1986). *Objects of desire: Design and society since 1750*. London, United Kingdom: Thames and Hudson.
- Foster, S., & Halbstein, D. (2014). *Integrating 3D modeling, photogrammetry and design*. Berlin, Germany: Springer Science & Business Media.
- Frankl, P., & Crossley, P. (2000). *Gothic architecture*. New Haven, CT, USA: Yale University Press.
- Frijda, N. H. (1986). *The emotions*. Cambridge, United Kingdom: Cambridge University Press.
- Gallagher, S., & Zahavi, D. (2012). *The phenomenological mind*. Abingdon, United Kingdom: Routledge.
- Gaver, W. W. (1991). Technology affordances. In *Proceedings of the SIGCHI Conference on Human Factors in Computing Systems* (pp. 79–84). New York, NY, USA: ACM. doi: 10.1145/108844.108856
- Gibson, J. J. (1979). *The ecological approach to visual perception*. Abingdon, United Kingdom: Routledge.
- Glazer, T. (2017). The part-whole perception of emotion. *Consciousness and Cognition*, 58, 34–43. doi: 10.1016/j.concog.2017.10.008
- Greenhalgh, P. (1990). *Modernism in design*. London, United Kingdom: Reaktion Books.
- Hann, M. (2012). *Structure and form in design: Critical ideas for creative practice*. London, United Kingdom: Bloomsbury Publishing.
- Hannah, G. G. (2002). *Elements of design: Rowena Reed Kostellow and the structure of visual relationships*. Princeton, NJ, USA: Princeton Architectural Press.
- Hassenzahl, M., & Tractinsky, N. (2006). User experience: A research agenda. *Behaviour & Information Technology*, 25(2), 91–97. doi: 10.1080/01449290500330331
- Hekkert, P. (2006). Design aesthetics: Principles of pleasure in design design aesthetics—Principles of pleasure in design. *Psychology Science*, 48(2), 157–172.
- Hekkert, P., & Berghman, M. (2016). The beauty of balance: An empirical integration of the unified model of aesthetics for product design. In P. Lloyd & E. Bohemia (Eds.), *Proceedings of DRS2016: Design + Research + Society - Future-Focused Thinking* (Vol 1; pp 277–292). London, United Kingdom: Design Research Society. doi: 10.21606/drs.2016.440
- Hogarth, W. (1997). *The analysis of beauty* (R. Paulson, Ed.). New Haven, CT, USA: Yale University Press. (Original work published 1753)
- House, J. (2004). *Impressionism: Paint and politics*. New Haven, CT, USA: Yale University Press.
- Howard, J. (1996). *Art nouveau: International and national styles in Europe*. Manchester, United Kingdom: Manchester University Press.
- Hume, D. (2017). *Of the standard of taste* (J. Bennett, Ed.). Retrieved from <http://www.earlymoderntexts.com/authors/hume> (Original work published 1757)
- Ingold, T. (2009). The textility of making. *Cambridge Journal of Economics*, 34(1), 91–102. doi: 10.1093/cje/bep042
- Izard, C. E. (2009). Emotion theory and research: Highlights, unanswered questions, and emerging issues. *Annual Review of Psychology*, 60(1), 1–25. doi: 10.1146/annurev.psych.60.110707.163539
- James, W. (1884). What is an emotion? *Mind*, 9(34), 188–205.
- Jordan, P. W. (2000). *Designing pleasurable products: An introduction to the new human factors*. Abingdon, United Kingdom: Taylor & Francis.
- Kaplan, W., Tigerman, B., Adamson, G., & Los Angeles County Museum of Art. (2011). *California design, 1930–1965: Living in a modern way*. Cambridge, MA, USA: MIT Press.
- Kolb, D. (1992). *Postmodern sophistications: Philosophy, architecture, and tradition*. Chicago, IL, USA: University of Chicago Press.
- Krippendorff, K. (2005). *The semantic turn: A new foundation for design*. Boca Raton, FL, USA: CRC Press.
- Krippendorff, K., & Butter, R. (1984). Product semantics: Exploring the symbolic qualities of form. *Innovations*, 3, 4–9.
- Lazarus, R. S. (1991). *Emotion and adaptation*. Oxford, United Kingdom: Oxford University Press.

- Leder, H., Belke, B., Oeberst, A., & Augustin, D. (2004). A model of aesthetics appreciation and aesthetic judgment. *British Journal of Psychology*, *95*, 489–508.
- Leder, H., & Carbon, C. C. (2005). Dimensions in appreciation of car interior design. *Applied Cognitive Psychology*, *19*(5), 603–618. doi: 10.1002/acp.1088
- Leder, H., & Nadal, M. (2014). Ten years of a model of aesthetic appreciation and aesthetic judgments: The aesthetic episode—Developments and challenges in empirical aesthetics. *British Journal of Psychology*, *105*(4), 443–446. doi: 10.1111/bjop.12084
- Lee, S., Self, J., & Andrietc, E. (2016). Most advanced yet acceptable: A case of referential form-driven meaning innovation. In P. Lloyd & E. Bohemia (Eds.), *Proceedings of DRS2016: Design + Research + Society - Future-Focused Thinking* (Vol 1; pp 157–177). London, United Kingdom: Design Research Society. doi: 10.21606/drs.2016.187
- Lévy, P. (2013). Beyond Kansei engineering: The emancipation of Kansei design. *International Journal of Design*, *7*(2), 83–94.
- Lewalski, Z. M. (1988). *Product esthetics: An interpretation for designers*. Carson City, NV, USA: Design and Development Engineering Press.
- Loos, A. (1976). Ornament and crime. In U. Conrads (Ed.), *Programs and manifestoes on 20th century architecture* (pp. 19–24). Cambridge, MA, USA: MIT Press. (Original work published 1913)
- McCracken, G. (1986). Culture and consumption: A theoretical account of the structure and movement of the cultural meaning of consumer goods. *Source Journal of Consumer Research*, *13*(1), 71–84.
- Mothersill, P., & Bove, V. M., Jr. (2015). The EmotiveModeler: An emotive form design CAD tool. *Extended Abstracts of the ACM CHI'15 Conference on Human Factors in Computing Systems* (pp. 339–342). New York, NY, USA: ACM. doi: 10.1145/2702613.2725433
- Niedderer, K. (2012). Exploring elastic movement as a medium for complex emotional expression in silver design. *International Journal of Design*, *6*(3), 57–69.
- Norman, D. A. (1988). *The psychology of everyday things*. New York, NY, USA: Basic Books.
- Norman, D. A. (1999). Affordance, conventions, and design. *Interactions*, *6*(3), 38–43. doi: 10.1145/301153.301168
- Norman, D. A. (2004). *Emotional design: Why we love (or hate) everyday things*. New York, NY, USA: Basic Books.
- Oxman, N. (2012). Material computation. In B. Sheil (Ed.), *Manufacturing the bespoke: Making and prototyping architecture* (pp. 256–265). Hoboken, NJ, USA: John Wiley & Sons, Inc.
- Pallasmaa, J. (2012). *The eyes of the skin: Architecture and the senses*. Hoboken, NJ, USA: John Wiley & Sons, Inc.
- Palumbo, L., & Bertamini, M. (2016). The curvature effect. *Empirical Studies of the Arts*, *34*(1), 35–52. doi: 10.1177/0276237415621185
- Panofsky, E. (1939). *Studies in iconology*. Oxford, United Kingdom: Oxford University Press.
- Pevsner, N. (1960). *Pioneers of modern design: From William Morris to Walter Gropius*. New Haven, CT, USA: Yale University Press.
- Pinna, B. (2010). New Gestalt principles of perceptual organization: An extension from grouping to shape and meaning. *Gestalt Theory*, *23*(1), 11–78.
- Plantinga, C. R., & Smith, G. M. (1999). *Passionate views: Film, cognition, and emotion*. Baltimore, MD, USA: Johns Hopkins University Press.
- Plutchik, R. (1980). *Emotion: A psychoevolutionary synthesis*. New York, NY, USA: Harper & Row.
- Plutchik, R. (2001). The nature of emotions: Human emotions have deep evolutionary roots. *American Scientist*, *89*(4), 344–350. doi: 10.1511/2001.4.344
- Poffenberger, A. T., & Barrows, B. E. (1924). The feeling value of lines. *Journal of Applied Psychology*, *8*(2), 187–205. doi: 10.1037/h0073513
- Porter, R. (2009). *Deleuze and Guattari: Aesthetics and politics*. Cardiff, United Kingdom: University of Wales Press.
- Quinn, B. (2004). *Mid-century modern: Interiors, furniture, design details*. London, United Kingdom: Conran Octopus.

- Raizman, D. S. (2003). *History of modern design: Graphics and products since the industrial revolution*. London, United Kingdom: Laurence King Publishing.
- Robertson, J. (2015). *The enlightenment: A very short introduction*. Oxford, United Kingdom: Oxford University Press.
- Rockmore, T. (2013). *Art and truth after Plato*. Chicago, IL, USA: University of Chicago Press. doi: 10.7208/chicago/9780226040165.001.0001
- Russell, J. A. (2003). Core affect and the psychological construction of emotion. *Psychological Review*, *110*(1), 145–172. doi: 10.1037/0033-295X.110.1.145
- Schachter, S., & Singer, J. E. (1962). Cognitive, social, and physiological determinants of emotional state. *American Psychologist*, *69*(5), 379–399. doi: 10.1037/h0021465
- Scherer, K. R. (2005). What are emotions? And how can they be measured? *Social Science Information*, *44*(4), 695–729. doi: 10.1177/0539018405058216
- Shaver, P., Schwartz, J., Kirson, D., & O'Connor, C. (1987). Emotion knowledge: Further exploration of a prototype approach. *Journal of Personality and Social Psychology*, *52*(6), 1061–1086. doi: 10.1037/0022-3514.52.6.1061
- Silvia, P. J. (2005). Emotional responses to art: From collation and arousal to cognition and emotion. *Review of General Psychology*, *9*(4), 342–357. doi: 10.1037/1089-2680.9.4.342
- Smock, W. (2009). *The Bauhaus ideal, then and now: An illustrated guide to modern design*. Chicago, IL, USA: Academy Chicago Publishers.
- Solomon, R. C. (1977). The logic of emotion. *Noûs*, *11*(1), 41–49. doi: 10.2307/2214329
- Staats, A. W., & Eifert, G. H. (1990). The paradigmatic behaviorism theory of emotions: Basis for unification. *Clinical Psychology Review*, *10*(5), 539–566. doi: 10.1016/0272-7358(90)90096-S
- Sudjic, D. (2008). *The language of things: Design, luxury, fashion, art—How we are seduced by the objects around us*. London, United Kingdom: Penguin Books.
- Sudjic, D. (2011). *The edifice complex: The architecture of power*. London, United Kingdom: Penguin Books.
- Tanizaki, J. (1933). *In praise of shadows*. London, United Kingdom: Vintage Books.
- Urquhart, L., & Wodehouse, A. (2016). Form as an abstraction of mechanism. In P. Lloyd & E. Bohemia (Eds.), *Proceedings of DRS2016: Design + Research + Society - Future-Focused Thinking* (Vol. 5; pp 1953–1969). Brighton, United Kingdom: Design Research Society. doi: 10.21606/drs.2016.78
- Vardouli, T. (2015). Making use: Attitudes to human–artifact engagements. *Design Studies*, *41*, 137–161. doi: 10.1016/j.destud.2015.08.002
- Wertheimer, M. (1923). Untersuchungen zur lehre von der gestalt. II. [Laws of organization in perceptual forms]. *Psychologische Forschung*, *4*(1), 301–350. doi: 10.1007/BF00410640
- Whyte, J., Bouchlaghem, N., Thorpe, A., & McCaffer, R. (2000). From CAD to virtual reality: Modelling approaches, data exchange and interactive 3D building design tools. *Automation in Construction*, *10*(1), 43–55. doi: 10.1016/S0926-5805(99)00012-6
- Xenakis, I., & Arnellos, A. (2013). The relation between interaction aesthetics and affordances. *Design Studies*, *34*(1), 57–73. doi: 10.1016/j.destud.2012.05.004
- You, H., & Chen, K. (2007). Applications of affordance and semantics in product design. *Design Studies*, *28*(1), 23–38. doi: 10.1016/j.destud.2006.07.002
- Zafirovski, M. (2011). *The enlightenment and its effects on modern society*. New York, NY, USA: Springer Publishing.
- Zangwill, N. (2001). *The metaphysics of beauty*. New York, NY, USA: Cornell University Press.
-

Authors' Note

All images have been sourced using fair-use protocol and are free to use within the public domain. Attribution has been provided when necessary.

All correspondence should be addressed to
Lewis Urquhart
University of Strathclyde
James Weir Building – Level 7 (DMEM)
75 Montrose Street
Glasgow, Scotland
G1 1XJ
lewis.urquhart@strath.ac.uk

Human Technology
ISSN 1795-6889
www.humantechnology.jyu.fi